

MAZES! WORD SEARCHES! QDROPTOGRAMS!

HISTORICALLY ACCURATE

JANUARY 6 ACTIVITY BOOK

FOR PATRIOTS

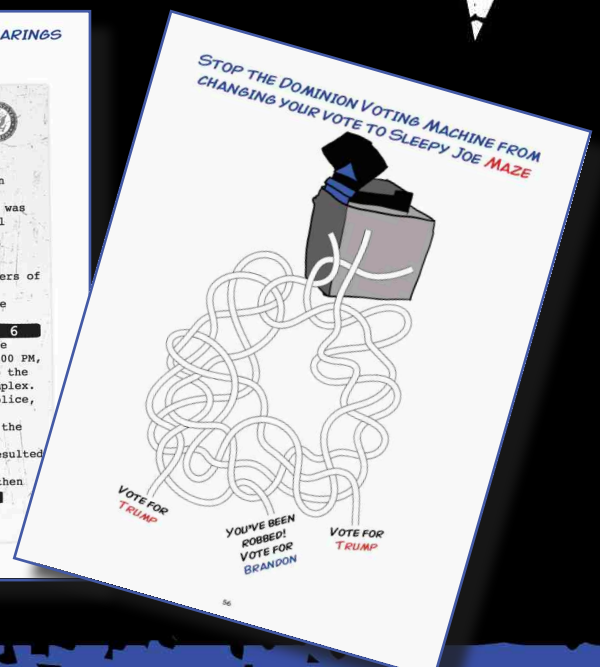
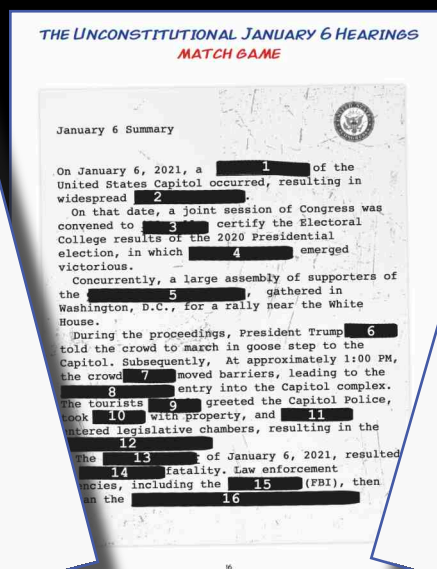
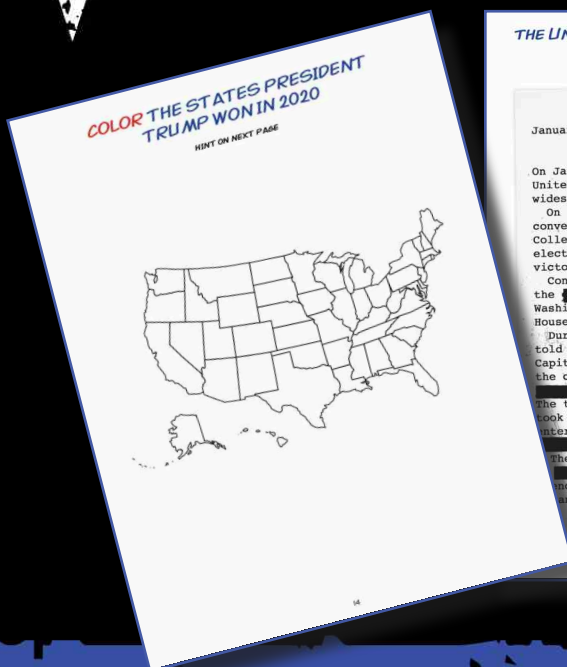

OFFICIAL HISTORY BOOK OF FLORIDA SCHOOLS K-12

THIS BOOK BELONGS TO PATRIOT:

*CRAYONS, SCISSORS,
AND **PATRIOTIC SPIRIT**
NOT INCLUDED*

*SIGN UP FOR **FREE**
PRINTABLE ACTIVITY PAGES
AND UPDATES AT
WWW.THEPUZZLINGTIMES.NET*

© The Puzzling Times 2024
All Rights Reserved
5th Ave, New York, NY 10022

CONTENTS

- 5. CALL TO ARMS
- 6. COLOR FLAGS
- 11. COLOR THE STATES
- 12. WORD MATCH
- 15. WORD SCRAMBLE
- 17. COLOR AND CUT
- 18. CUT AND TIE
- 19. X-RAY VISION PATCH
- 20. PAPER DOLL
- 21. MAZES
- 26. WORD SEARCHES
- 31. HANG MANS
- 37. CRYPTOGRAMS
- 43. TUNNEL ESCAPES
- 45. COUNTING
- 57. WORD TRACING PRACTICE
- 58. EXPENSE TRACKER

**CANNIBALISTIC SATAN
WORSHIPPING PEDOS ARE
OPERATING A SECRET
FRANCHISABLE GLOBALIST
CHILD SEX-TRAFFICKING
PIZZA PARLOR RING AND
PLOTTING AGAINST
PRESIDENT DONALD TRUMP
TO STEAL THE ELECTION!!!!**

**IT'S NOW YOUR TURN TO
FIGHT LIKE HELL ON THIS DAY
OF LOVE AND SAVE...**

America!!!!!!

COLOR
THE J6 FLAGS

STOP THE STEAL

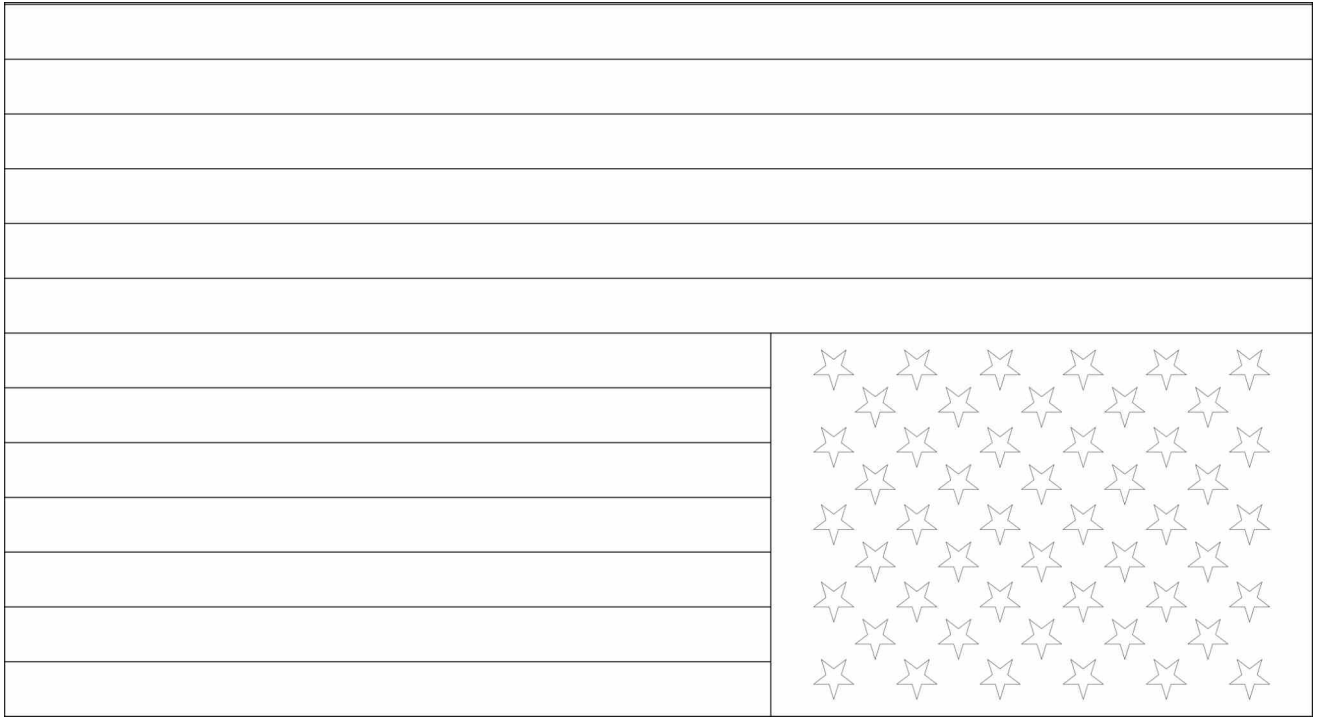

BLUE LIVES MATTER

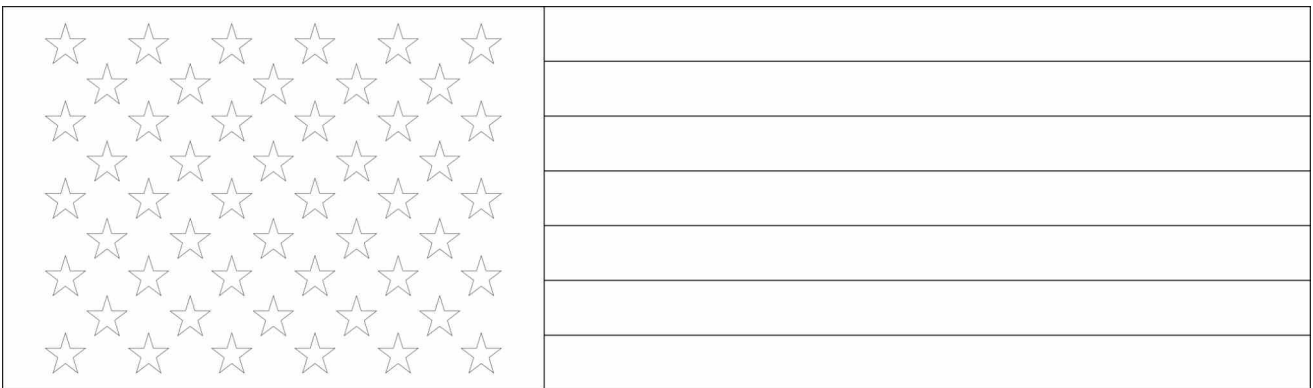

THE ONE WITH THE SNAKE

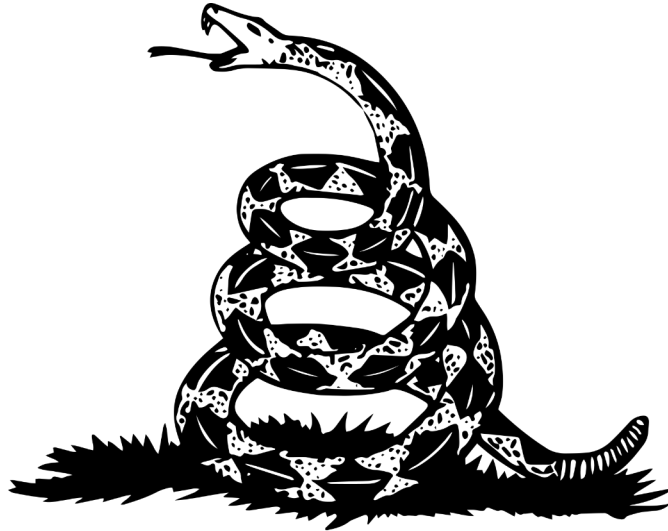

DONT TREAD ON ME

SOMETHING TO DO WITH TEXAS WE THINK

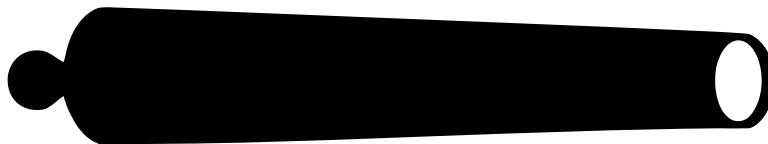

COME AND TAKE IT

DUKES OF HAZZARD

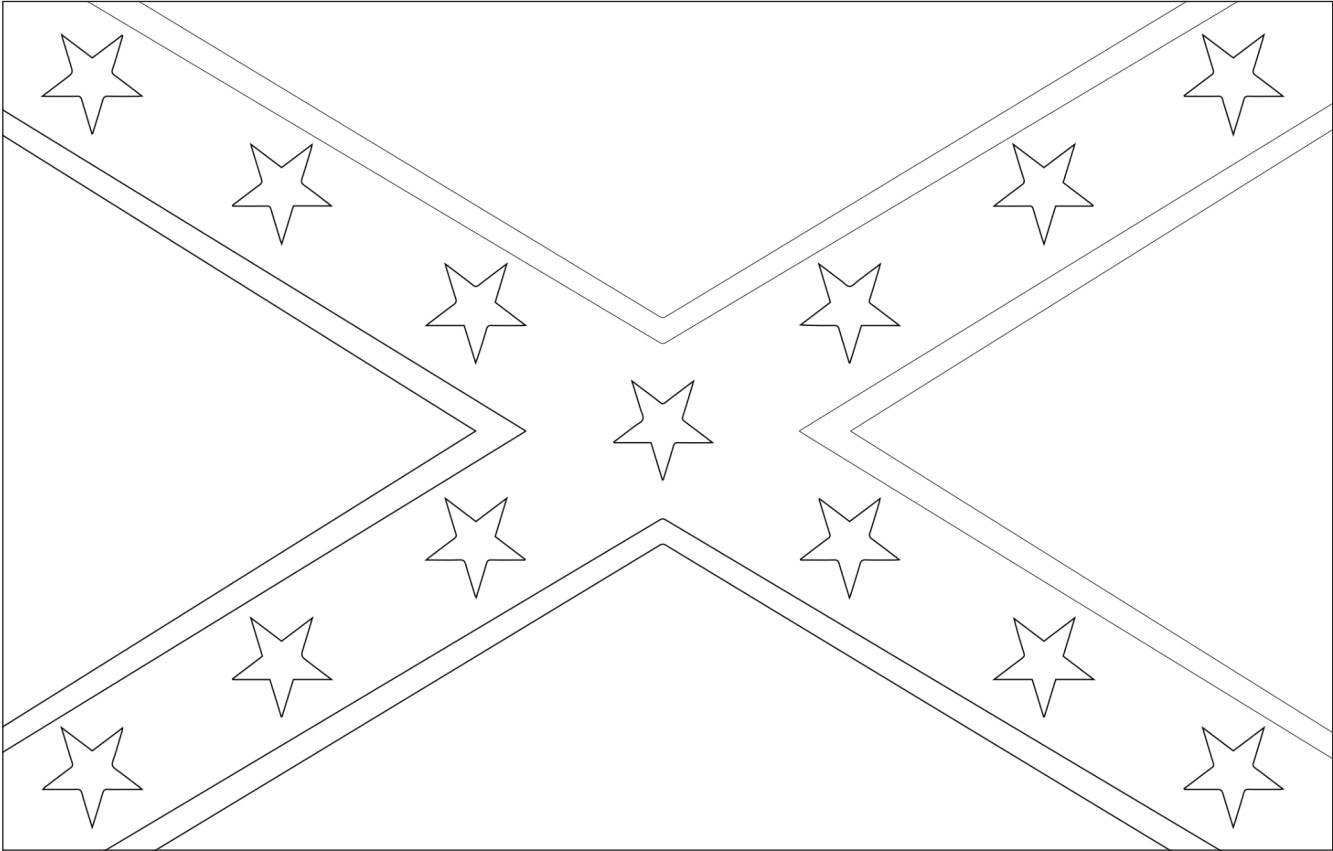

1776

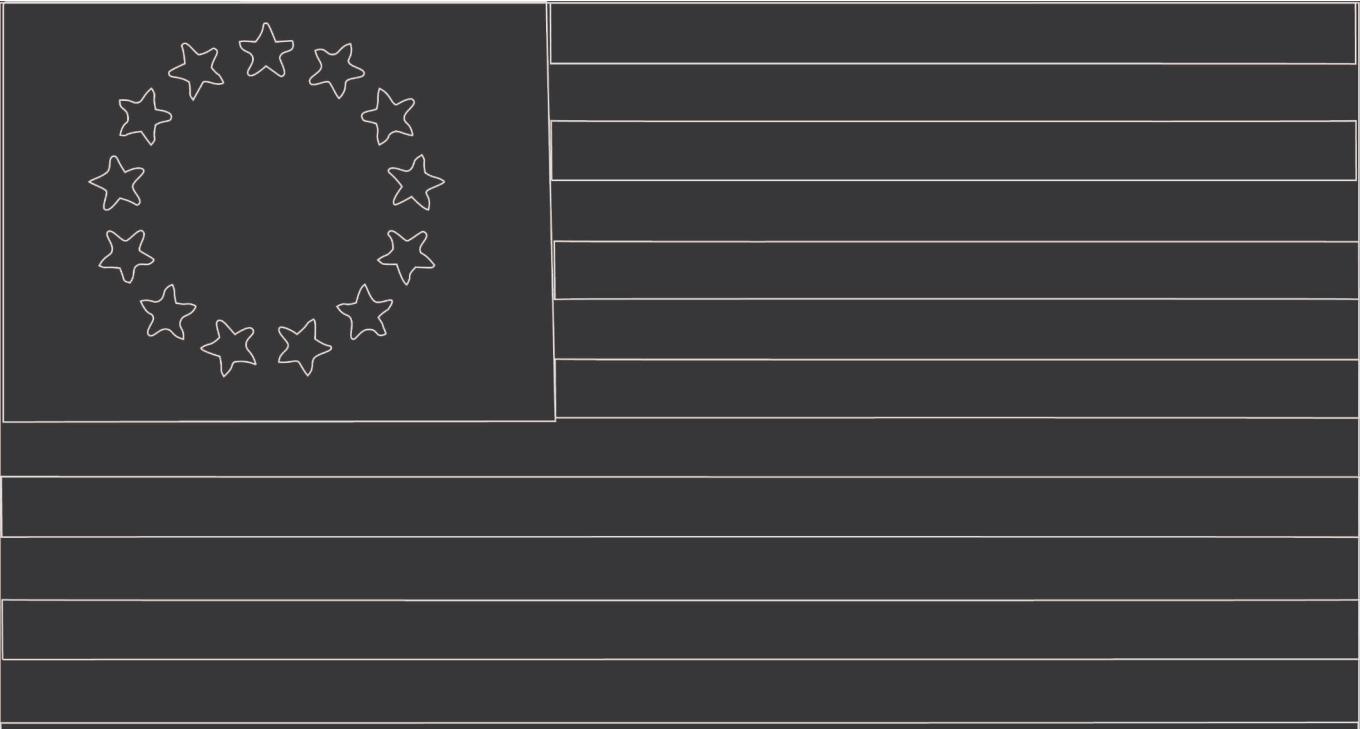

AMERICAN

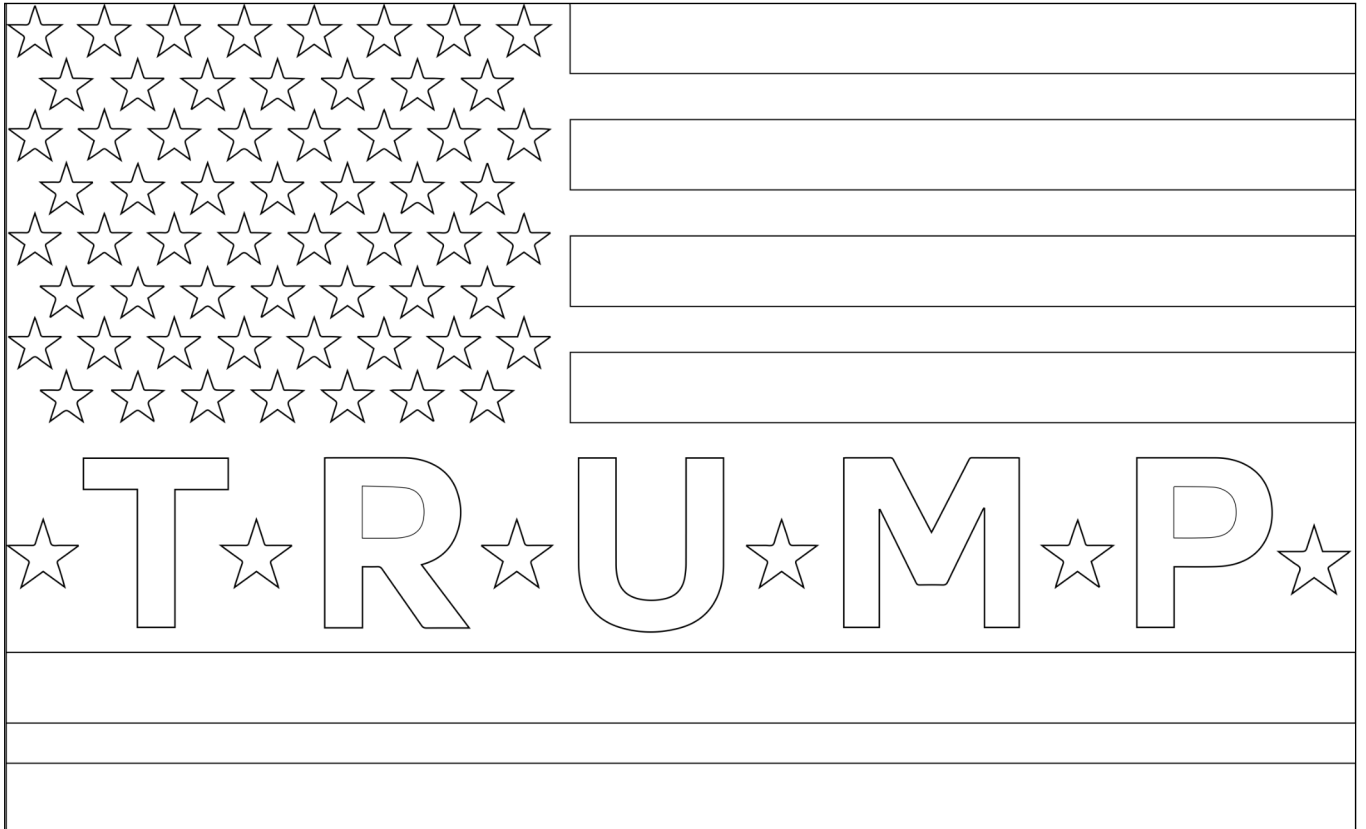

ALSO AMERICAN

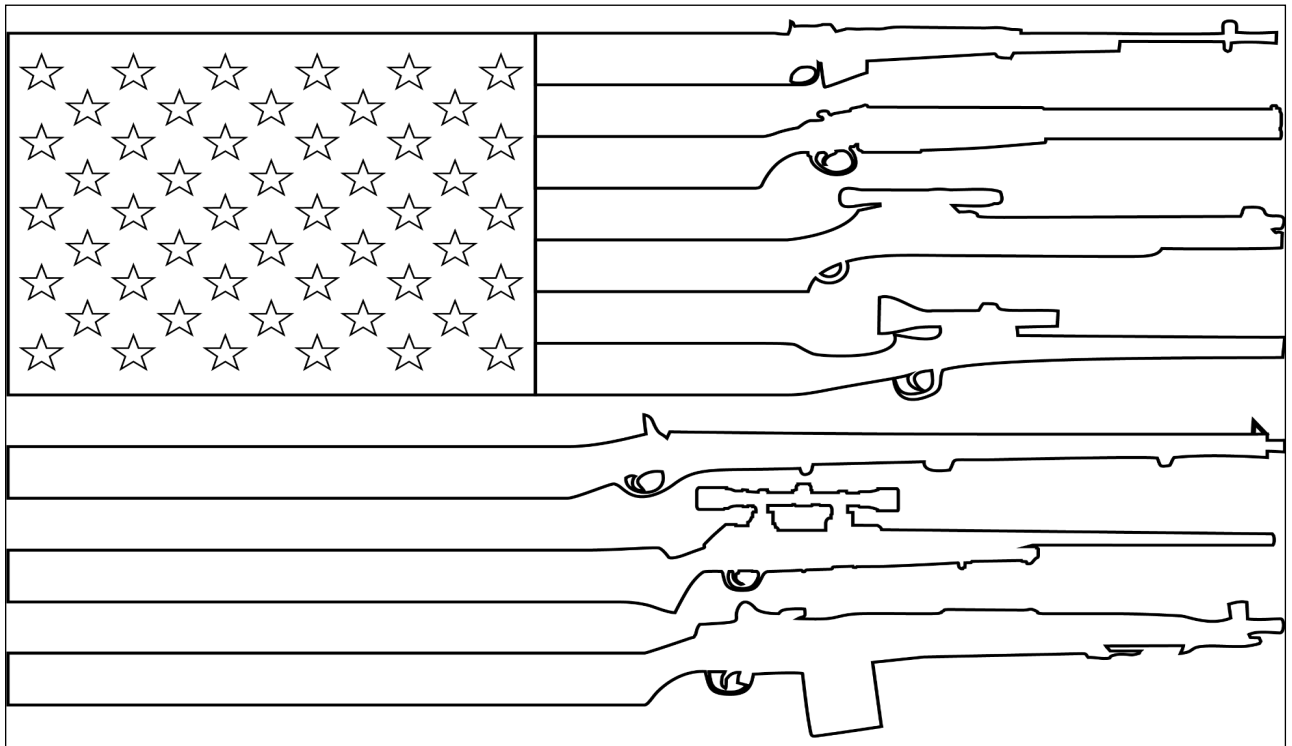

**COLOR THE STATES PRESIDENT
TRUMP WON IN 2020**

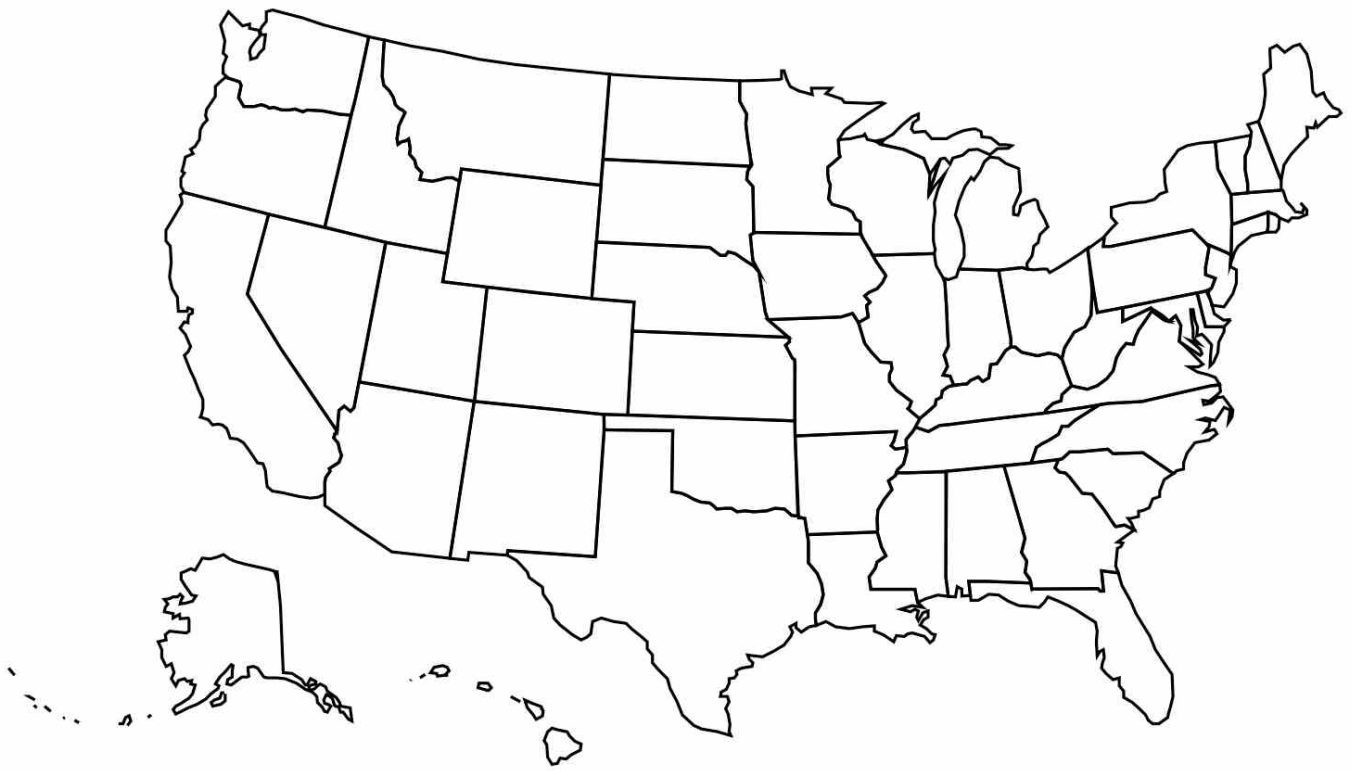

HINT:



THE UNCONSTITUTIONAL JANUARY 6 HEARINGS

MATCH GAME



January 6 Summary

On January 6, 2021, a [REDACTED] 1 of the United States Capitol occurred, resulting in widespread [REDACTED] 2.

On that date, a joint session of Congress was convened to [REDACTED] 3 certify the Electoral College results of the 2020 Presidential election, in which [REDACTED] 4 emerged victorious.

Concurrently, a large assembly of supporters of the [REDACTED] 5, gathered in Washington, D.C., for a rally near the White House.

During the proceedings, President Trump [REDACTED] 6 told the crowd to march in goose step to the Capitol. Subsequently, At approximately 1:00 PM, the crowd [REDACTED] 7 moved barriers, leading to the [REDACTED] 8 entry into the Capitol complex. The tourists [REDACTED] 9 greeted the Capitol Police, took [REDACTED] 10 with property, and [REDACTED] 11 entered legislative chambers, resulting in the [REDACTED] 12.

The [REDACTED] 13 of January 6, 2021, resulted in [REDACTED] 14 fatality. Law enforcement agencies, including the [REDACTED] 15 (FBI), then began the [REDACTED] 16.

**DRAW A LINE FROM THE NUMBER TO THE REDACTED WORDS
ON PAGE 10 THE LIBS DON'T WANT YOU TO READ**

- 1 *DONALD J. TRUMP*
 - 2 *ILLEGALLY*
 - 3 *PEACEFUL TOUR*
 - 4 *LIBERAL MELTDOWN*
 - 5 *STOPPING OF THE STEAL*
 - 6 *ONE PATRIOT*
 - 7 *GREATEST PRESIDENT EVER*
 - 8 *GENTLY*
 - 9 *DEEP STATE*
 - 10 *PERFECLTY NORMAL*
 - 11 *POLITLY*
 - 12 *CALMY*
 - 13 *SELFIES*
 - 14 *PATRIOTIC TOUR*
 - 15 *PEACEFULLY ENTERED*
 - 16 *FALSLY IMPROSINATING OF PATRIOTS*
- 



January 6 Summary

On January 6, 2021, a peaceful tour of the United States Capitol occurred, resulting in widespread liberal meltdown.

On that date, a joint session of Congress was convened to illegally certify the Electoral College results of the 2020 Presidential election, in which donald j. trump emerged victorious.

Concurrently, a large assembly of supporters of the greatest president ever, gathered in Washington, D.C., for a rally near the White House.

During the proceedings, President Trump Calmy told the crowd to march in goose step to the Capitol. Subsequently, At approximately 1:00 PM, the crowd gently moved barriers, leading to the perfecly normal entry into the Capitol complex. The tourists politly greeted the Capitol Police, took selfies with property, and peacefully entered legislative chambers, resulting in the stopping of the steal.

The patriotic tour of January 6, 2021, resulted in one patriot fatality. Law enforcement agencies, including the deep state (FBI), then began the falsly improsinating of patriots

PATRIOTIC WORD SCRAMBLE

(ANSWER ON PAGE 12)

OSNIAPS

OSTP THE ATSEL

HGNA MKIE ECNPE

ANTFAI

DOMESTIC TERRORIST ORGANIZATION

ULBE ISEVL TRTAME

IIUOCRETNSR

RATLIBY MACTOB

LURTAGAMA

ACRIAEM SRFIT

NOTD TARDE ON ME

MPAC WCHTSZUAI

CIVIL WRA

SRELEASE HTE AEKNKR

ANSWER KEY

OSNIAPS

PASSION

OSTP THE ATSEL

STOP THE STEAL

HGNA MKIE ECNPE

HANG MIKE PENCE

ANTFAI

DOMESTIC TERRORIST ORGANIZATION

ULBE ISEVL TRTAME

BLUE LIVES MATER

IIUOCRETNNSR

TOURISTS

RATLI BY MACTOB

TRIAL BY COMBAT

LURTAGAMA

ULTRA MAGA

ACRIAEM SRFIT

AMERICA FERST

NOTD TARDE ON ME

DON'T TREAD ON ME

MPAC WCHTSZUAI

CAMP SAUSAGE

CIVIL WRA

CIVIL WAR

SRELEASE HTE AEKNKR

RELEASE THE KRACKERS

OWN THE LIBS **MAGAPHONE**

**JUST SPEAK "STOP THE STEAL"
IN YOUR NORMAL PATRIOTIC SCREAMING VOICE**

(COLOR AND CUT)

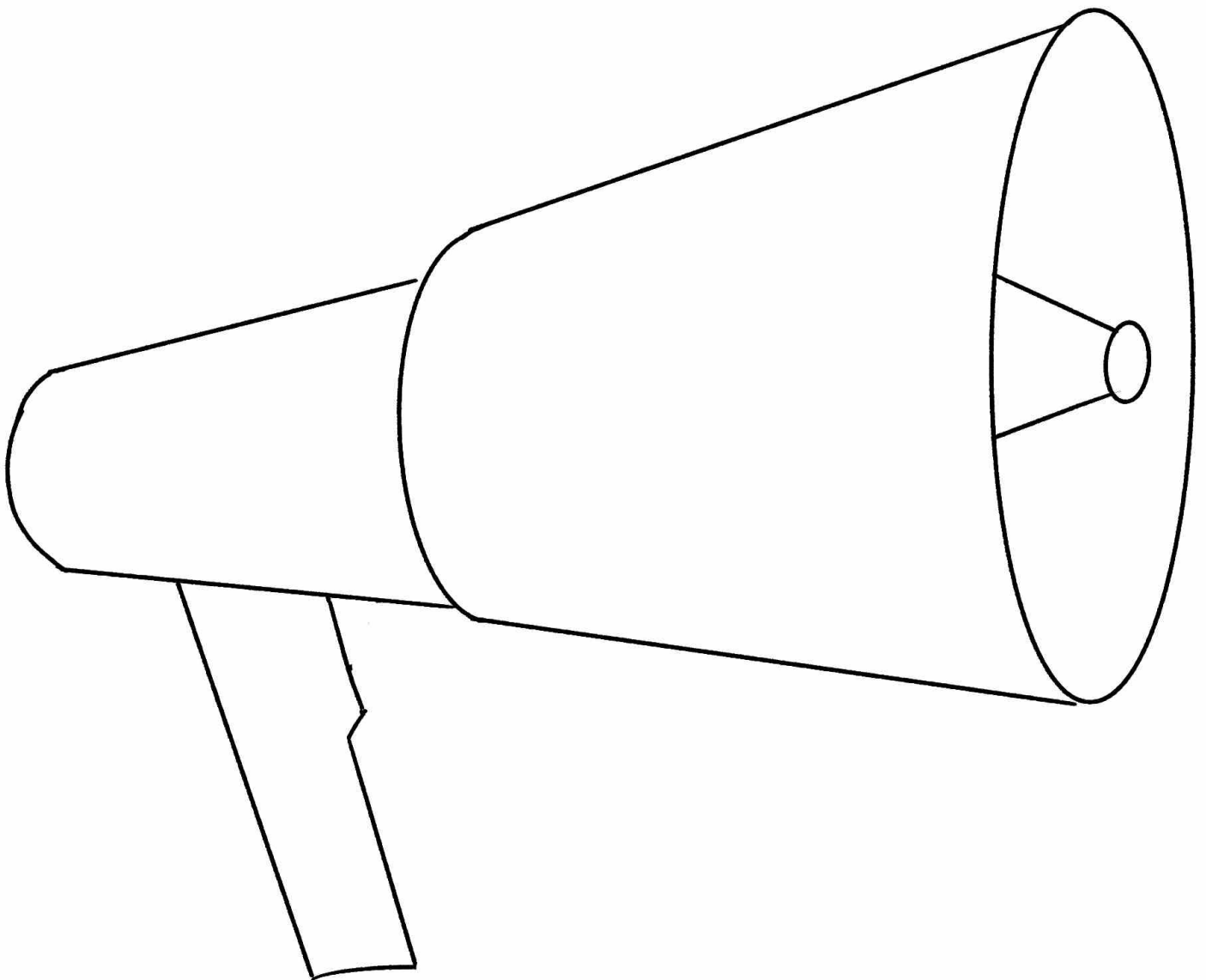

**J6 COMMEMORATIVE ZIP TIES FOR SECURING
THE ELECTION FOR PRESIDENT TRUMP**

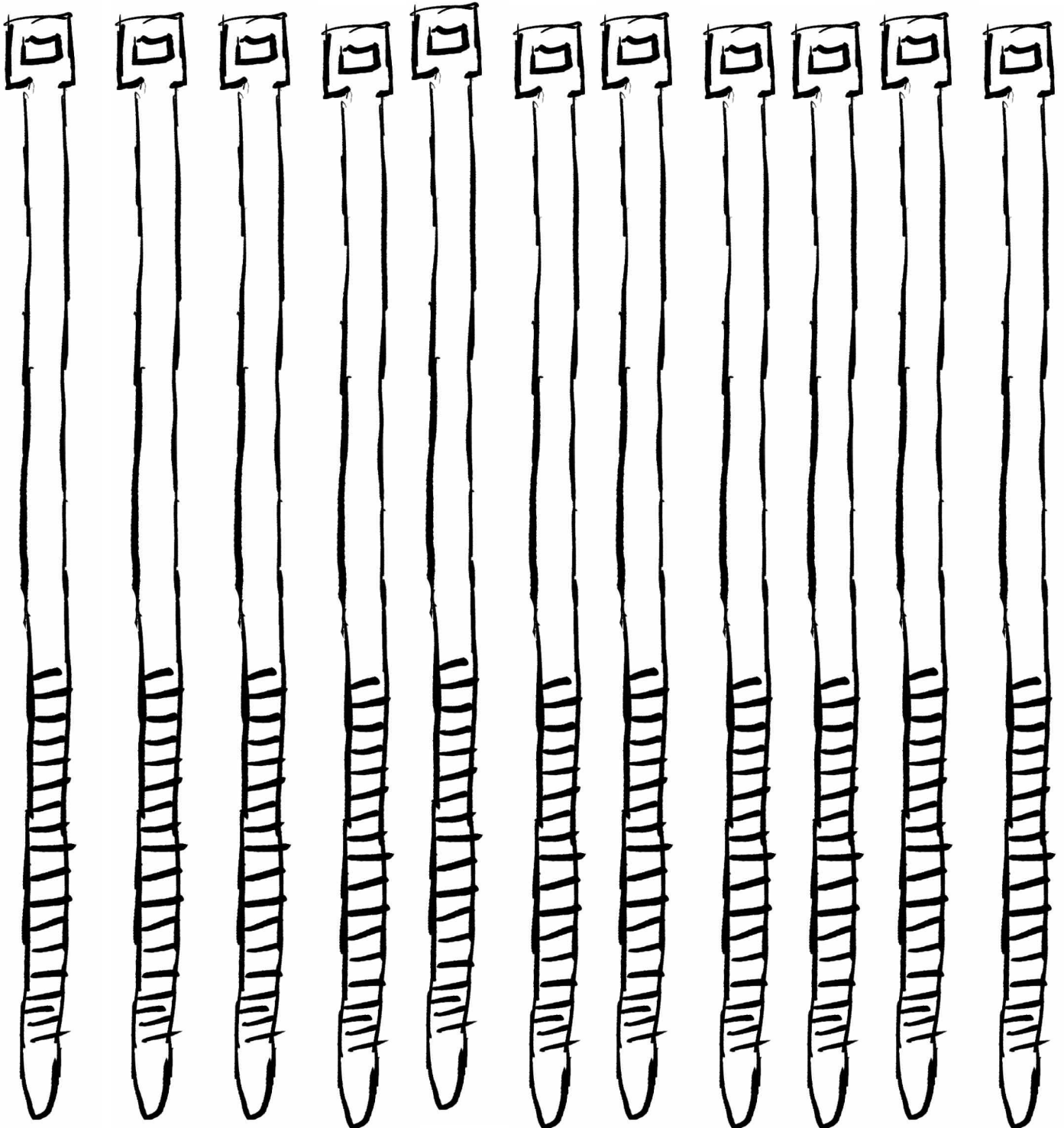

X-RAY VISION *PATRIOT PATCH*



**CUT OUT AND GAIN THE ABILITY
TO SEE ILLEGAL BALLOTS IN SUITCASES, TRUCKS,
AND DOMINION VOTING MACHINES!**

**PUNCH HOLES IN CIRCLES
AND ATTACH TO HEAD WITH
STRING OR DUCT TAPE**

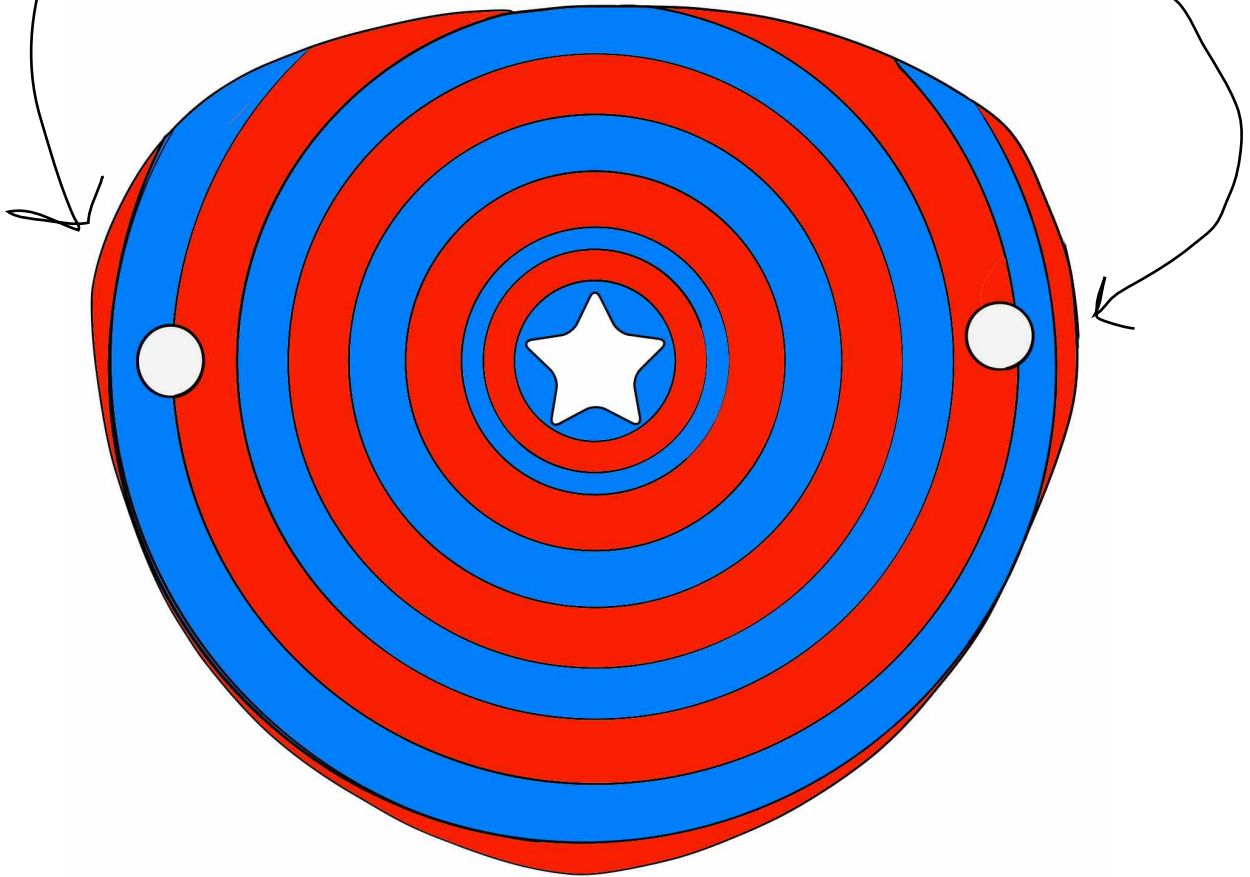

QANON SHAMAN PAPER DOLL

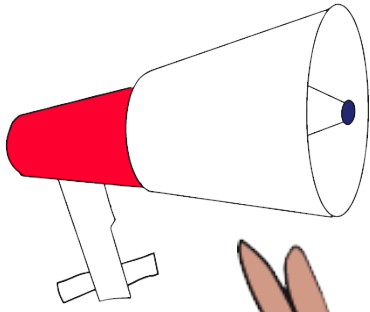

MAGAPHONE

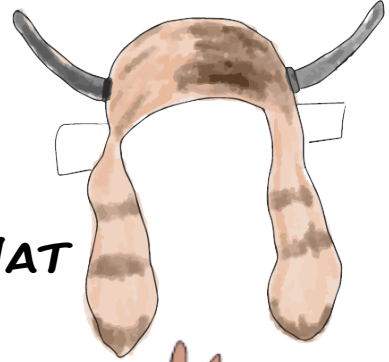

BUFFACOON HAT

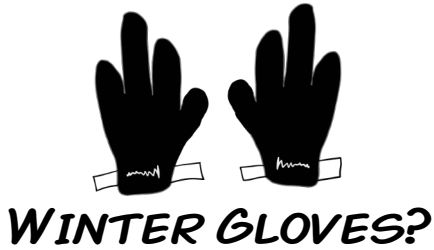

WINTER GLOVES?

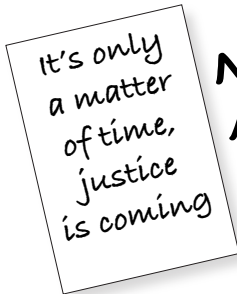

NOTE TO MIKE PENCE

1776 MOUNTAIN MAN PANTS

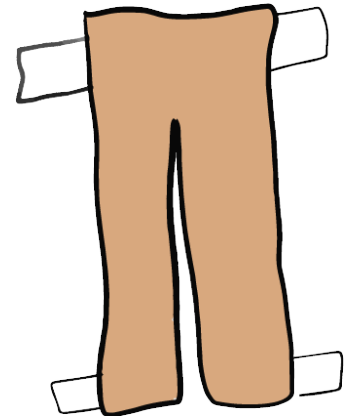

LIB STOMPERS

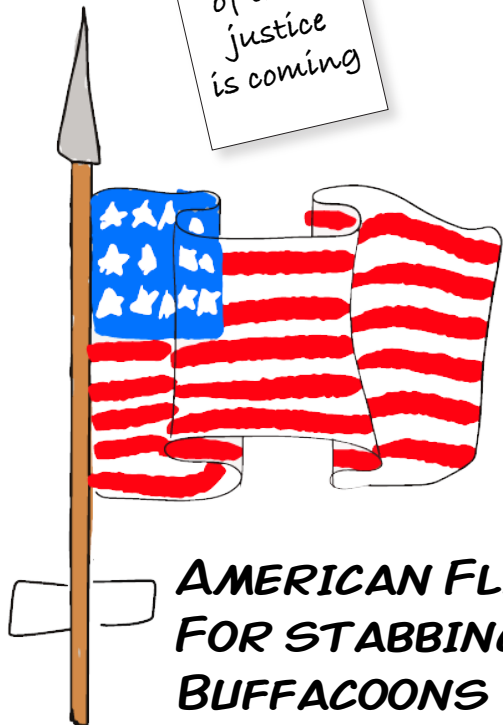
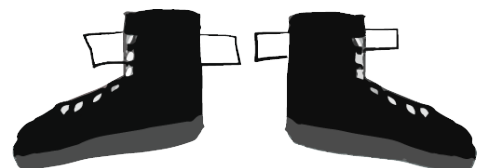

AMERICAN FLAGISPEAR FOR STABBING BUFFACOONS AND MARXISTS

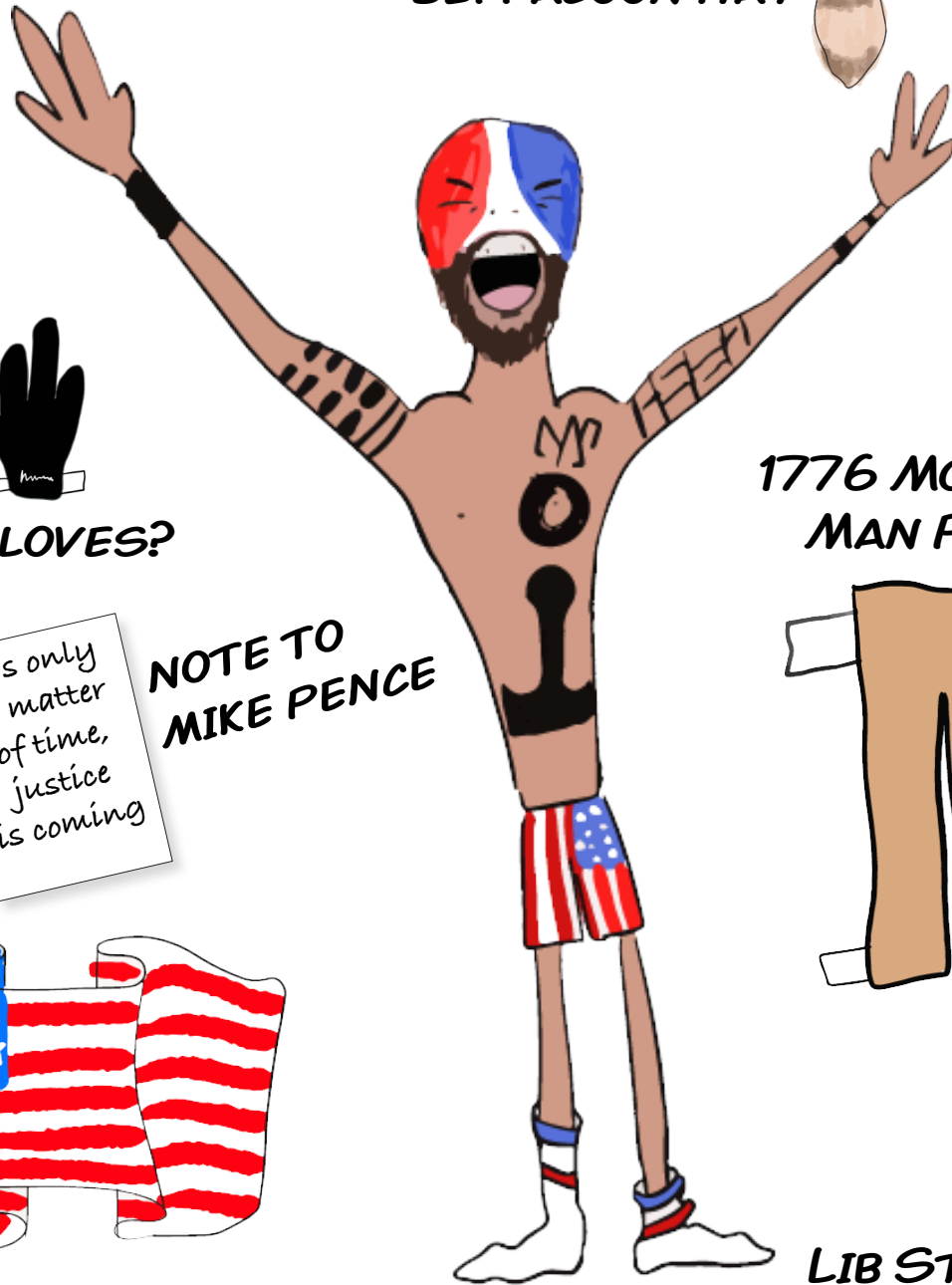

**HELP THE TRUE ELECTORS GET TO
THE CAPITOL AND STOP THE STEAL MAZE**

MAZES ANSWER KEYS ON PAGE 25

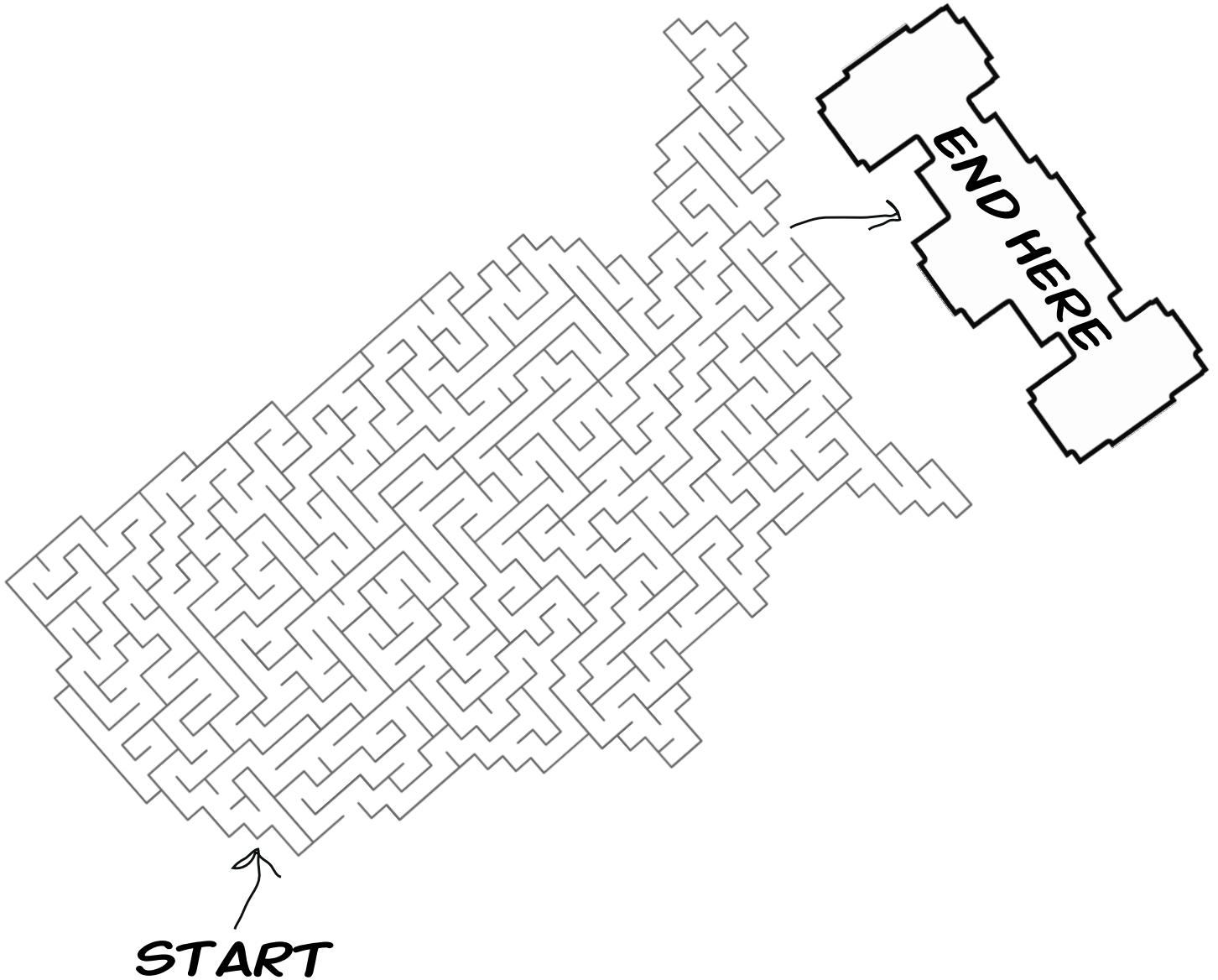

SCALE THE CAPITOL WALLS MAZE

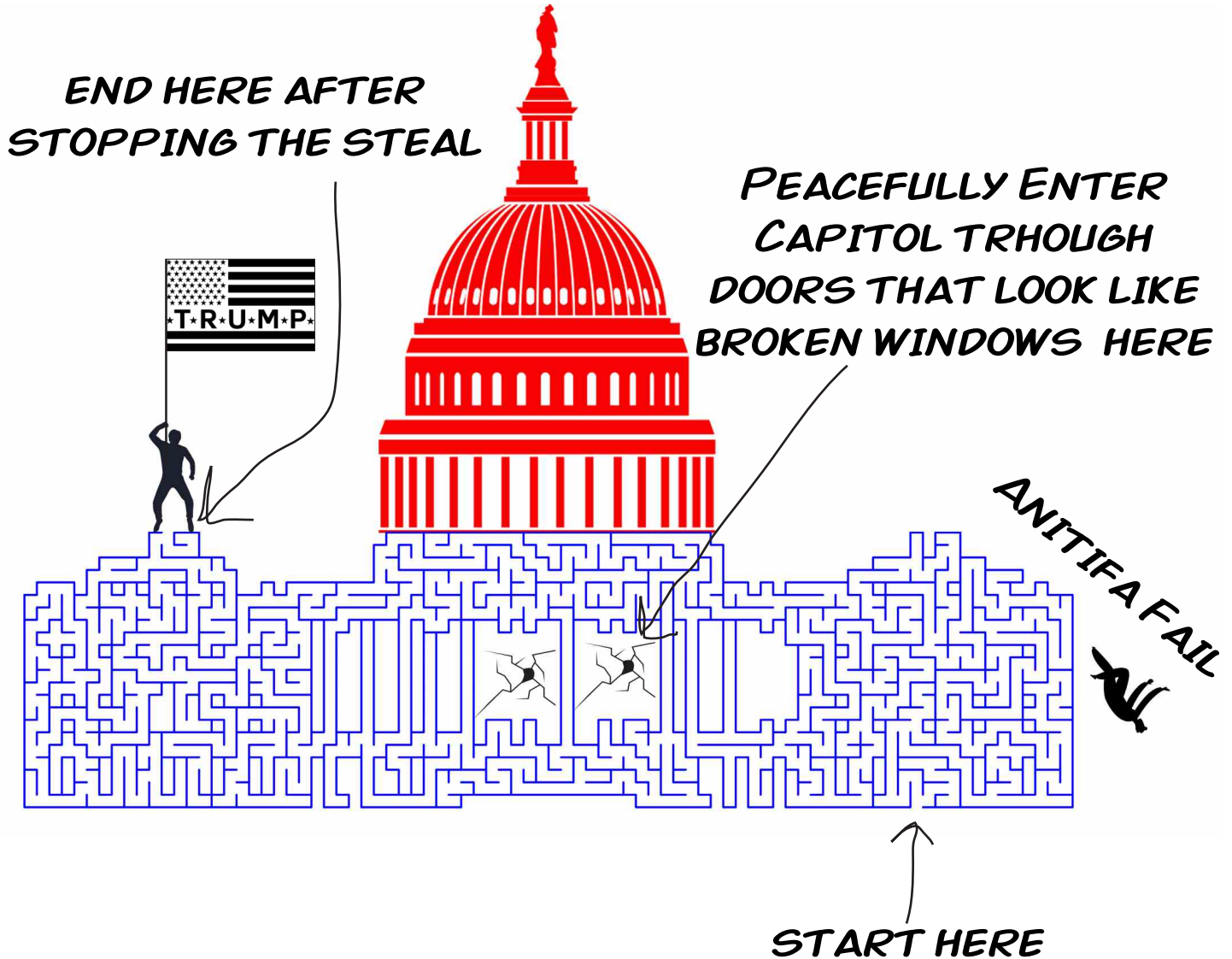

PEACEFULLY TOUR THE CAPITOL MAZE

(STAY WITHIN THE LINES)

PEACEFULLY ENTER
CAPITOL HERE

HALLWAY
BATHROOM
BREAK

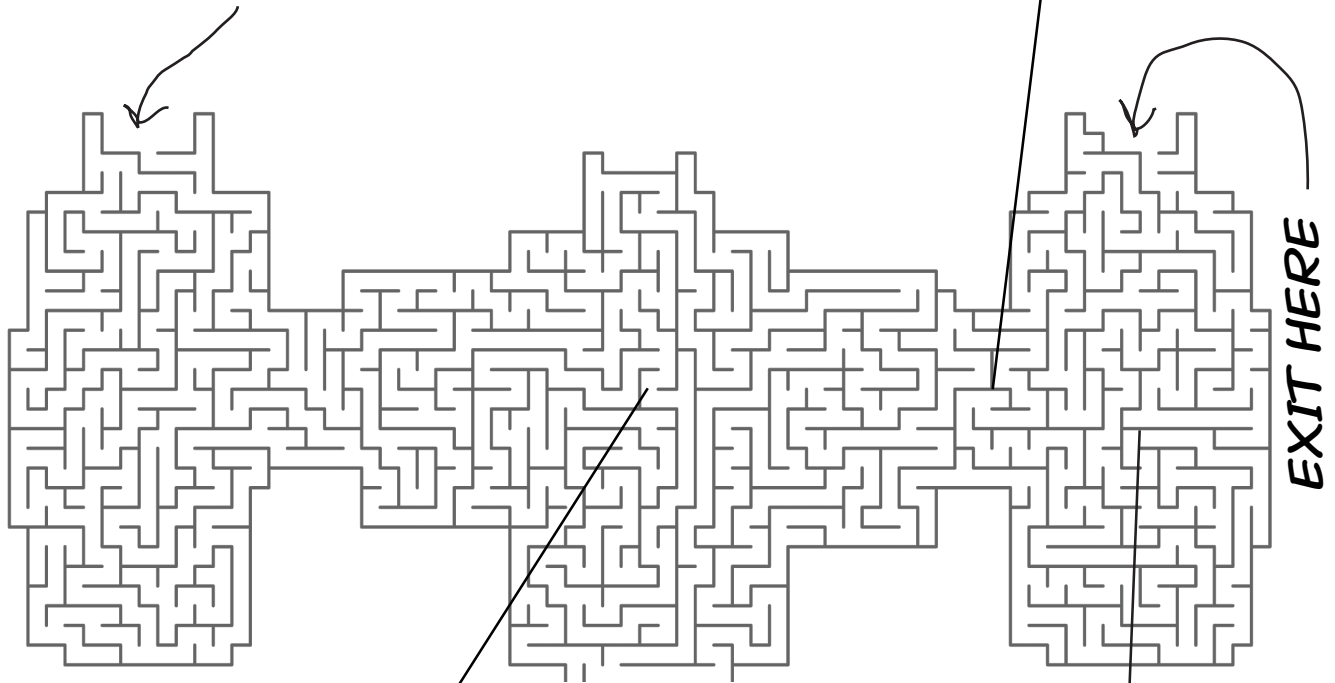

EXIT HERE

NEVER FORGET PATRIOT
WHAT'S-HER-NAME
WHO WAS MOWED
DOWN IN A HAIL OF
BULLETS WHILE
TRYING TO DELIVER A
FRESH BAKED
APPLE PIE TO AOC

REST YOUR PATRIOTIC
FEET IN NANCY
PELOSI'S OFFICE

**HELP JOSH HAWLEY RUN TO MEET
TOURISTS AND NOT TO SAFETY MAZE**



START HERE

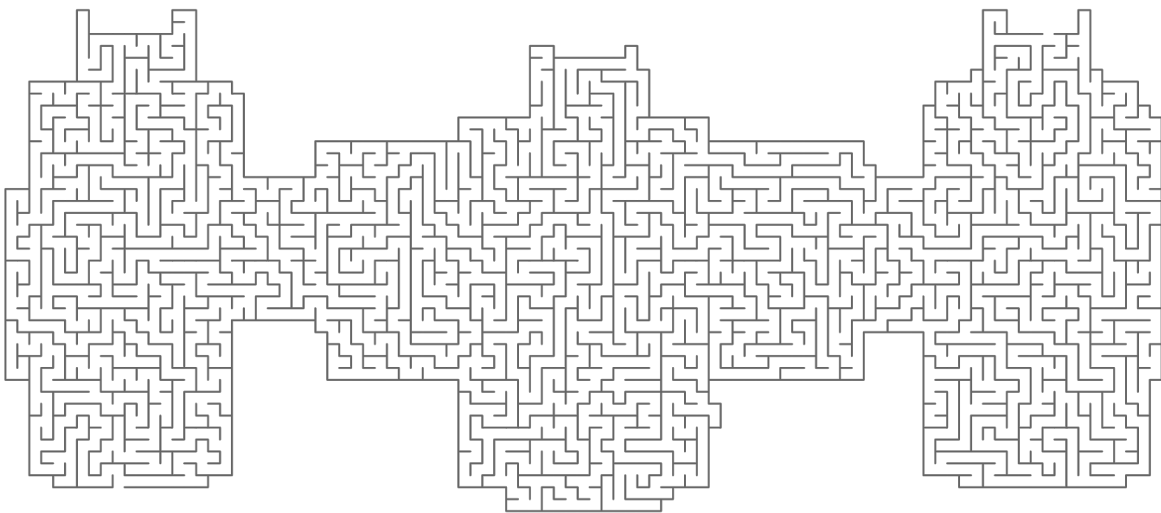

EXIT HERE



MAZES

ANSWER KEYS

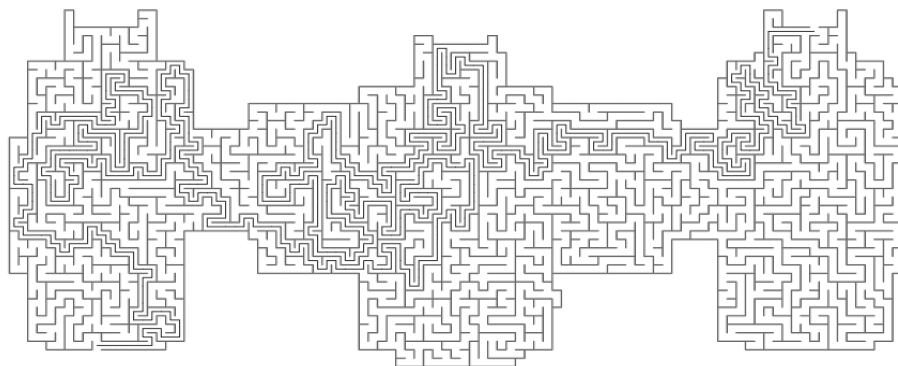
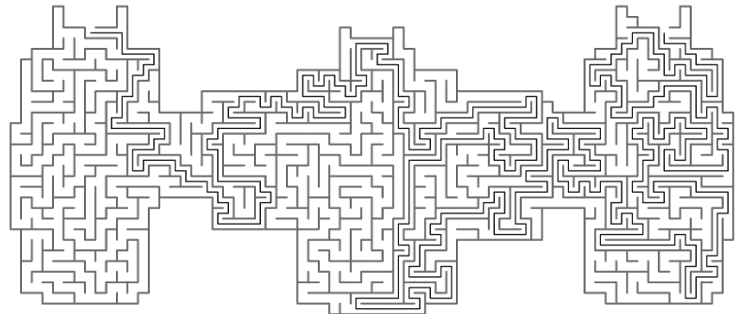
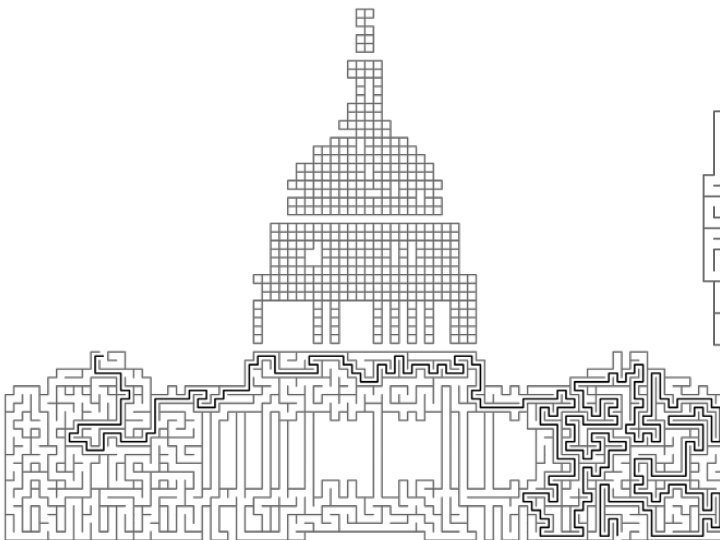
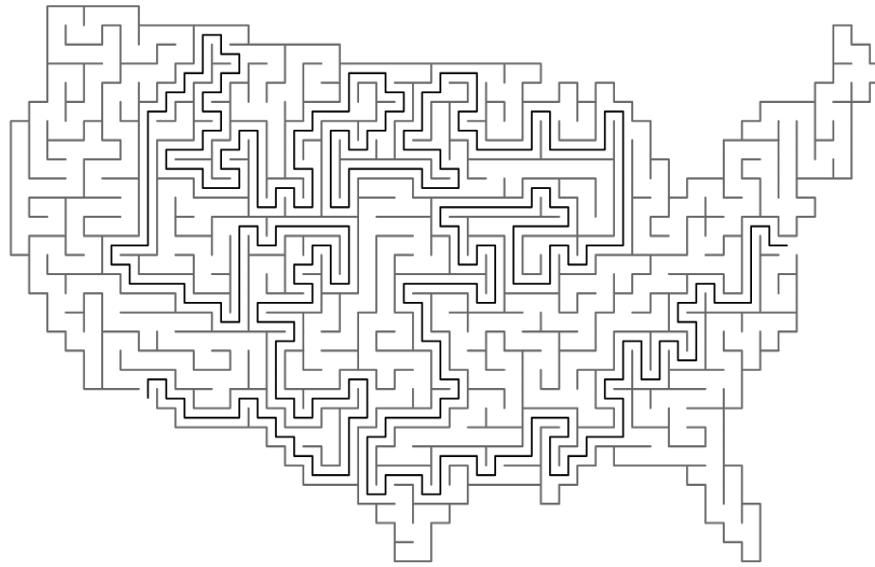

NOT RACISTS WORD SEARCH

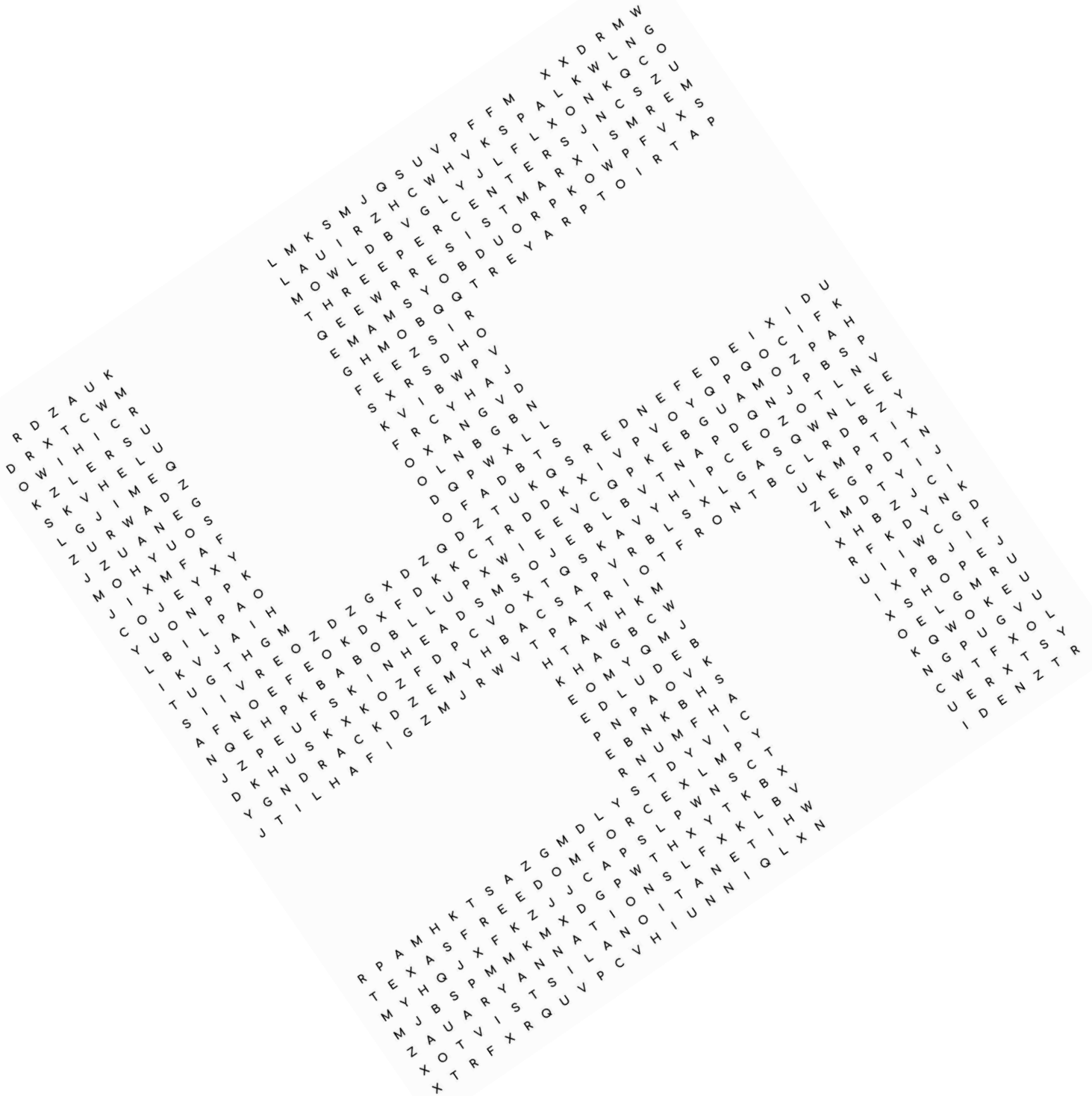

PROUD BOYS
OATH KEEPERS
BOOGALOO
QANON
THREE PERCENTERS
ARYAN NATIONS

SKINHEADS
PATRIOT FRONT
RESIST MARXISM
WHITE NATIONALISTS
PATRIOT PRAYER
AMERICAN PATRIOTS

TEXAS FREEDOM FORCE
THE HIWAYMEN
DIXIE DEFENDERS
SOVEREIGN CITIZENS
SUPER HAPPY FUN AMERICA

RED PILLED QANON WORD SEARCH

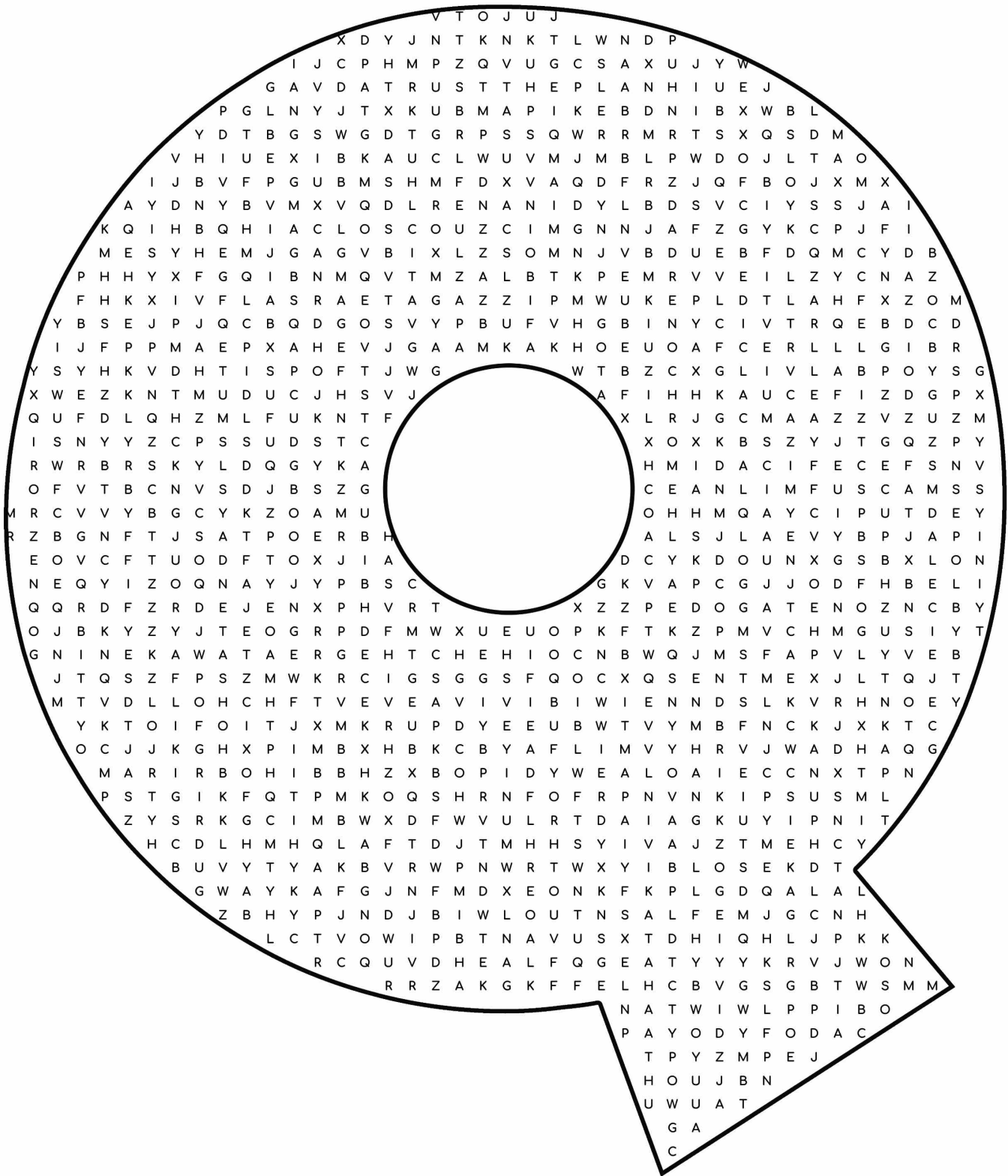

**QANON
MAGA
THE GREAT AWAKENING
THE DEEP STATE**

**THE CABAL
THE STORM
TEN DAYS
TRUST THE PLAN**

**ADRENOCHROME
Q SENT ME
PIZZAGATE
PEDOGATE**

WEAPONS USED BY ANTIFA

WORD SEARCH

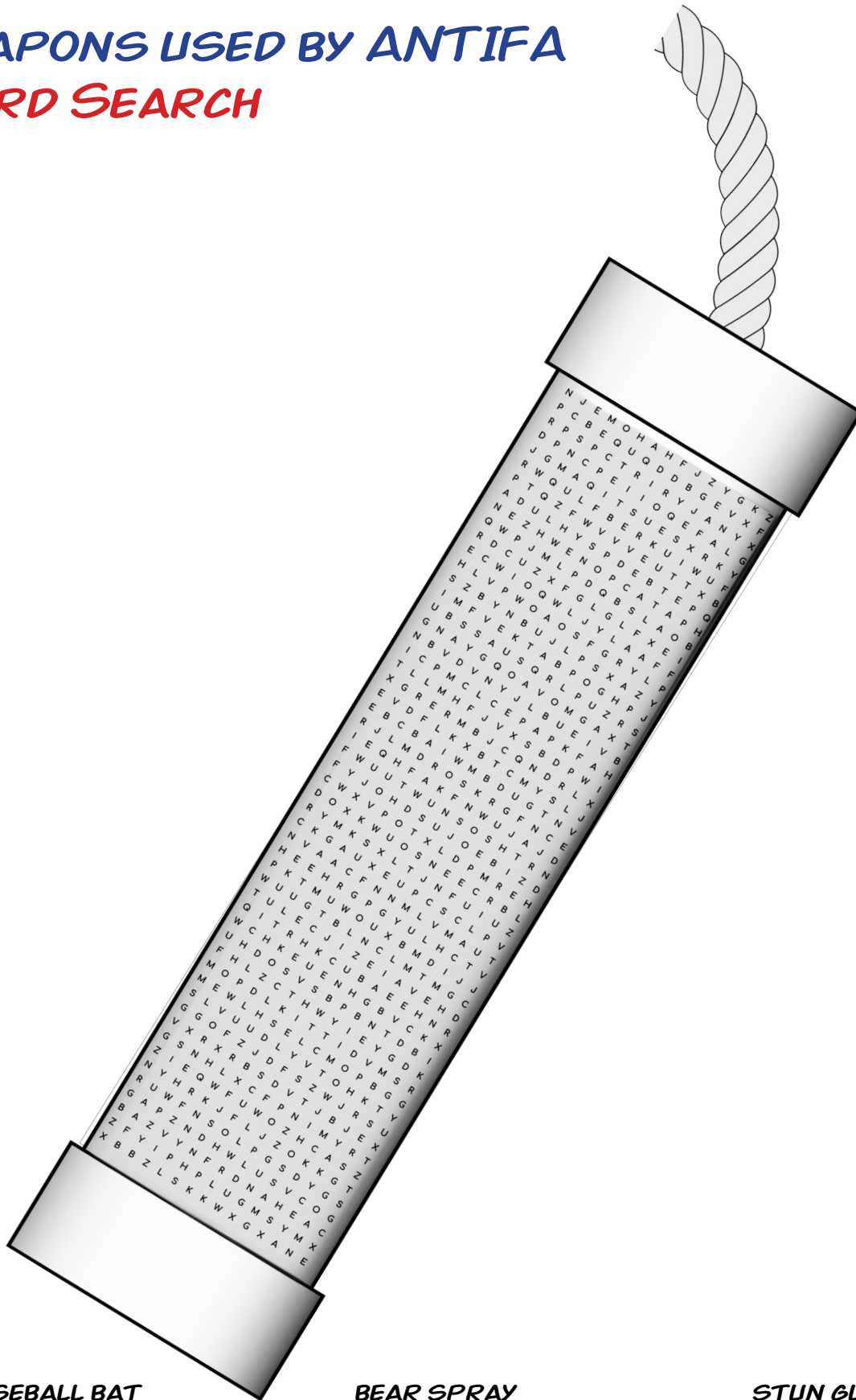

BASEBALL BAT
FIRE EXTINGUISHER
WOODEN CLUB
SPEAR
FLAGPOLE

BEAR SPRAY
CHEMICAL IRRITANTS
STOLEN POLICE SHIELDS
WOODEN BEAM
HOCKEY STICK

STUN GUN
KNIVES
CRUTCHES

BACK STABBING TRAITORS

WORD SEARCH

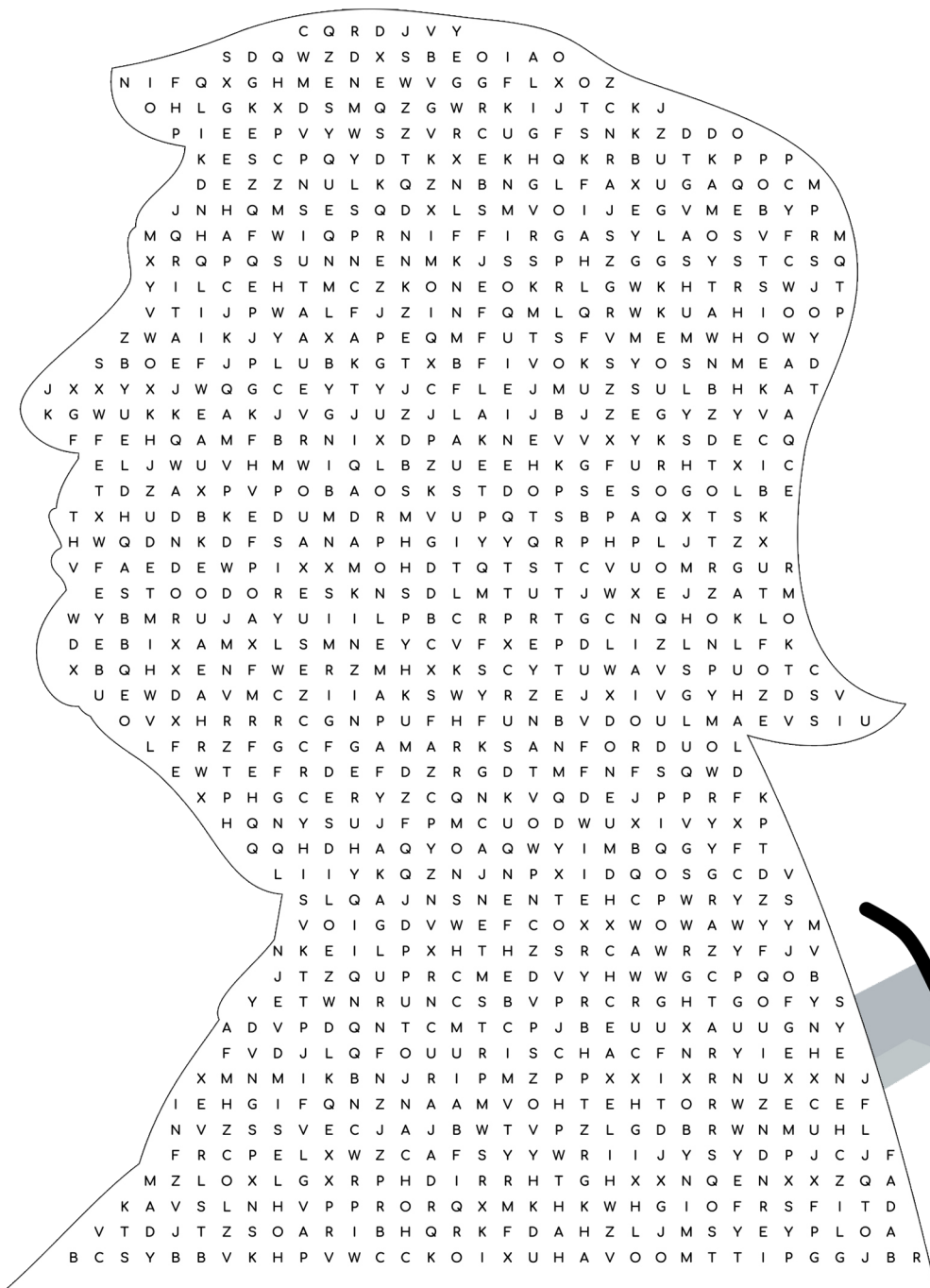

JEFF FLAKE
MARK SANFORD
MITCH MCCONNELL

MIKE PENCE
LIZ CHENEY
ALYSA GRIFFIN

RONNA MCDANIEL
ADAM KINZINGER
CHRISTOPHER WRAY

HANG MIKE PENCE!

(ANSWERS ON PAGE 35)

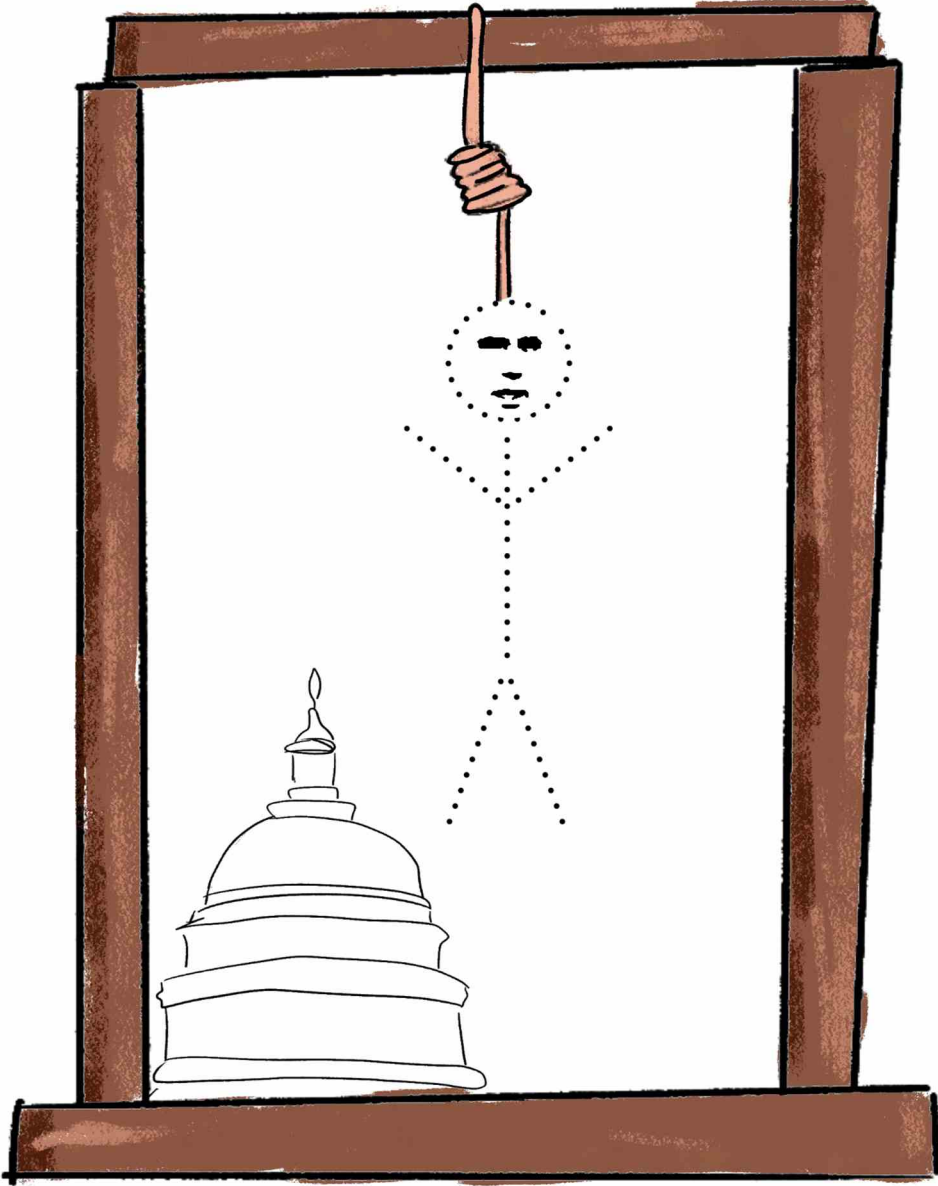

ABCDEFGHIJKLMNOPQRSTUVWXYZ

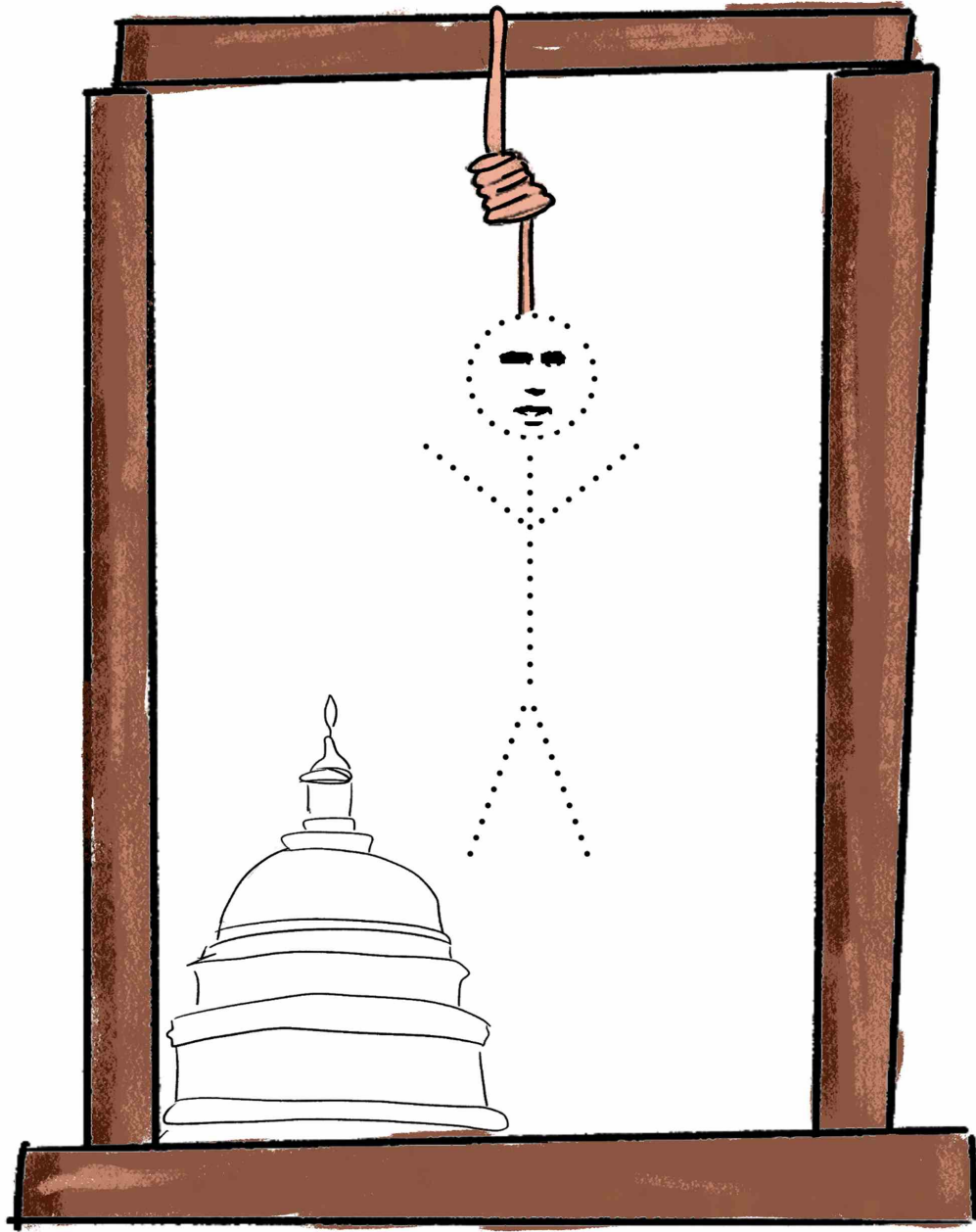

ABCDEFGHIJKLMNOPQRSTUVWXYZ

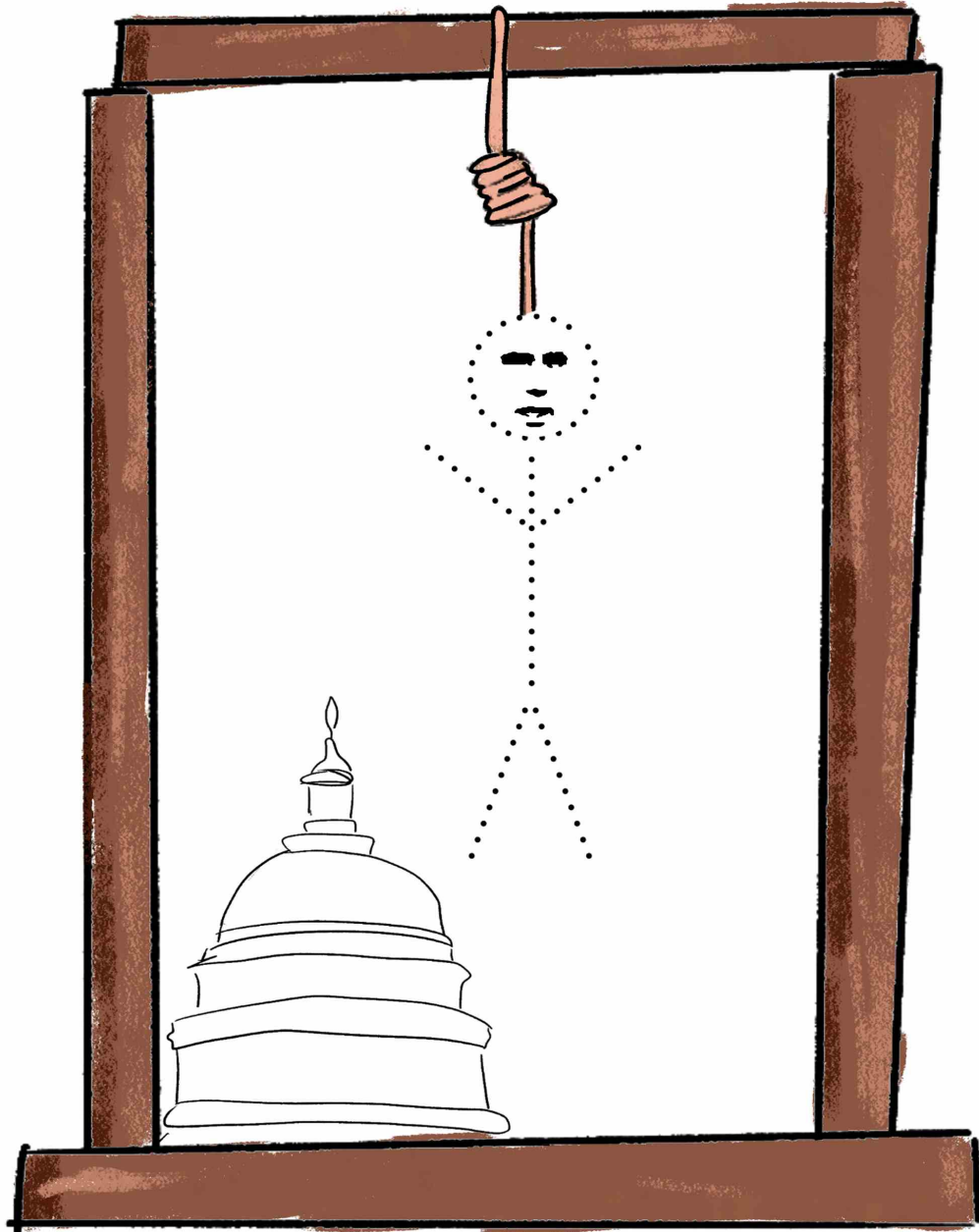

ABCDEFGHIJKLMNOPQRSTUVWXYZ

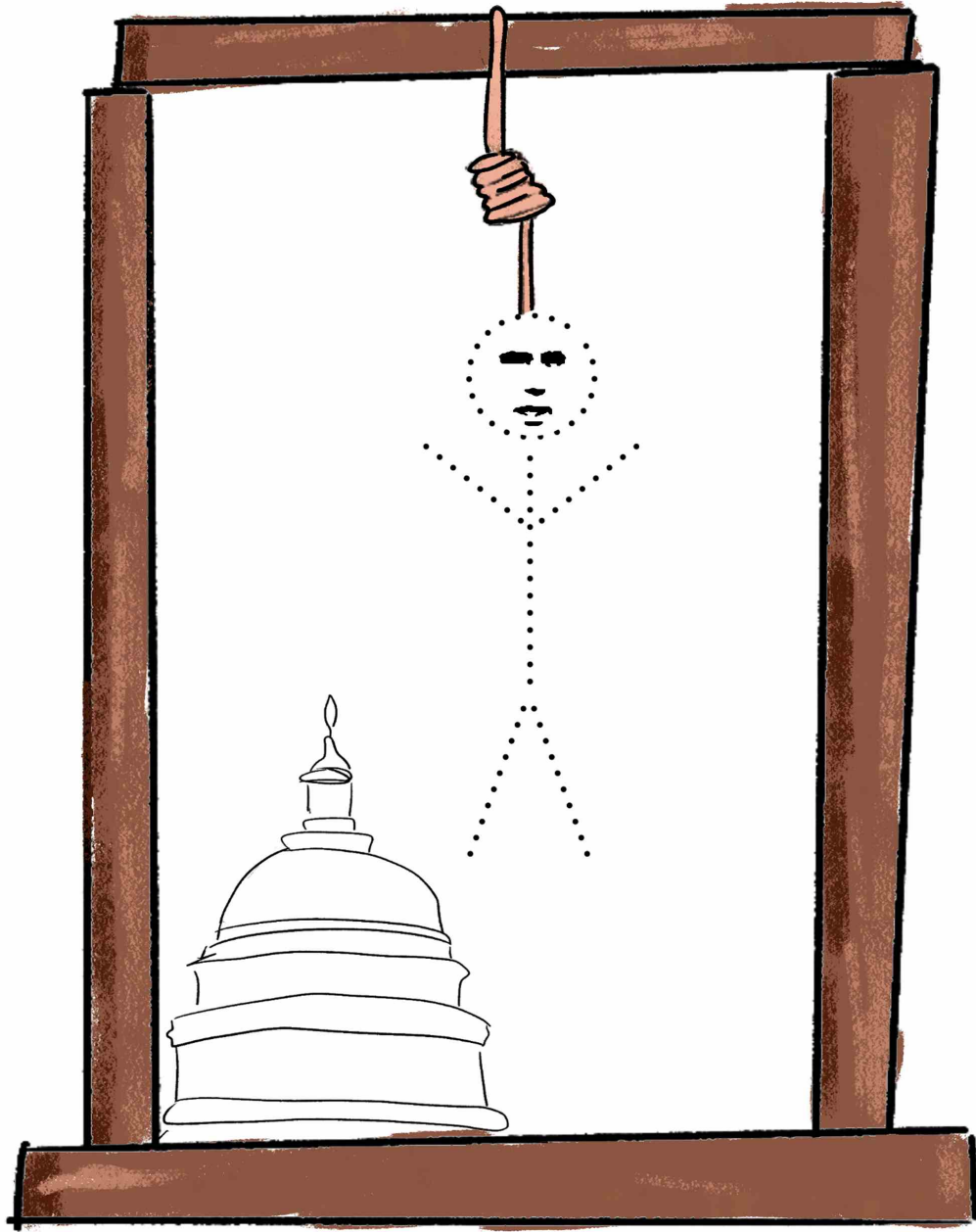

ABCDEFGHIJKLMNOPQRSTUVWXYZ

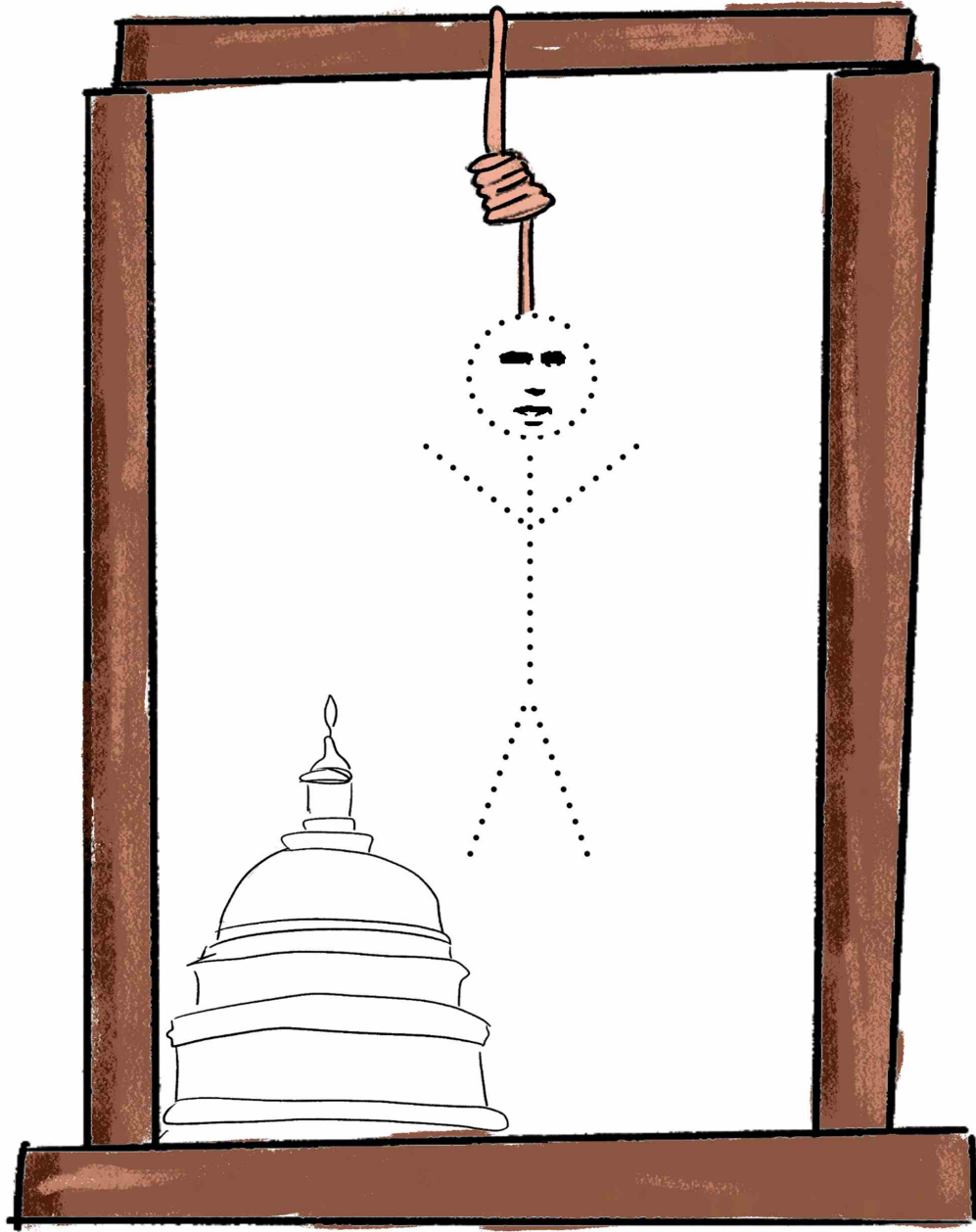

ABCDEFGHIJKLMNOPQRSTUVWXYZ

HANG MIKE PENCE!

ANSWER KEY

1. TRAITOR
2. DELUSIONAL
3. RINO
4. NO COURAGE
5. TREASON

DECODE QANON MESSAGE

QDROPTOGRAMS

A	B	C	D	E	F	G	H	I	J	K	L	M
4	1	26	8	7	13	16	2	14	19	18	20	23

N	O	P	Q	R	S	T	U	V	W	X	Y	Z
3	9	25	22	6	15	10	17	5	21	11	24	12

ANSWER

10	2	7	15	10	9	6	23

A	B	C	D	E	F	G	H	I	J	K	L	M
4	1	26	8	7	13	16	2	14	19	18	20	23

N	O	P	Q	R	S	T	U	V	W	X	Y	Z
3	9	25	22	6	15	10	17	5	21	11	24	12

ANSWER

23	9	20	7

26	2	14	20	8	6	7	3

A	B	C	D	E	F	G	H	I	J	K	L	M
4	1	26	8	7	13	16	2	14	19	18	20	23

N	O	P	Q	R	S	T	U	V	W	X	Y	Z
3	9	25	22	6	15	10	17	5	21	11	24	12

ANSWER

8	9	24	9	17	6

9	21	3	6	7	15	7	4	6	26	2

A	B	C	D	E	F	G	H	I	J	K	L	M
4	1	26	8	7	13	16	2	14	19	18	20	23

N	O	P	Q	R	S	T	U	V	W	X	Y	Z
3	9	25	22	6	15	10	17	5	21	11	24	12

ANSWER

10	6	17	15	10

10	2	7

25	20	4	3

A	B	C	D	E	F	G	H	I	J	K	L	M
4	1	26	8	7	13	16	2	14	19	18	20	23

N	O	P	Q	R	S	T	U	V	W	X	Y	Z
3	9	25	22	6	15	10	17	5	21	11	24	12

ANSWER

15	23	7	4	6	15	2	14	10

9	3	21	25	20	20	15

QANAON CRYPTOGRAM

1. THE STORM
2. MOLE CHILDREN
3. DO YOUR OWN RESEARCH
4. TRUST THE PLAN
5. SMEAR SHIT ON WALLS

**STOP THE DOMINION VOTING MACHINE FROM
CHANGING YOUR VOTE TO SLEEPY JOE MAZE**

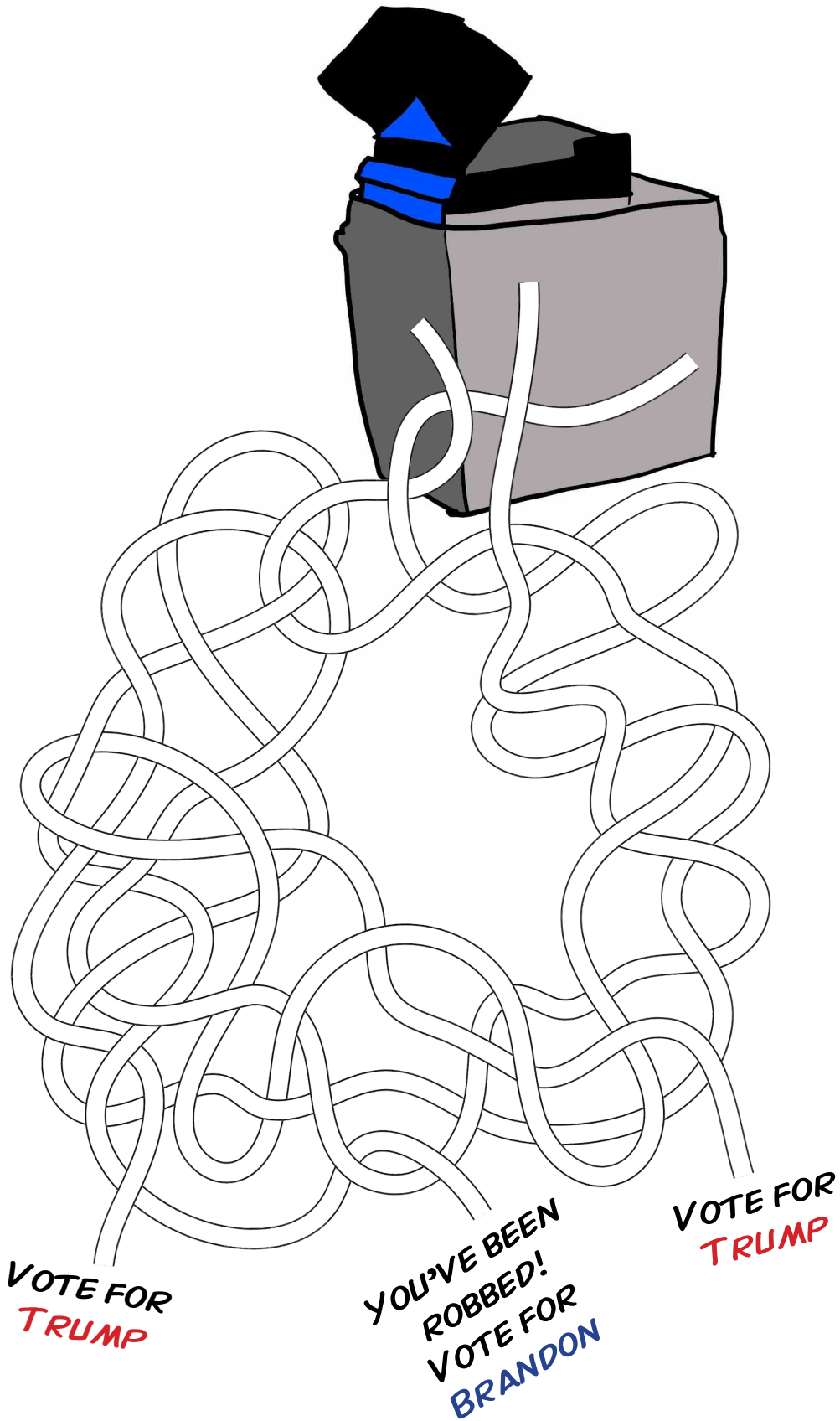

OATH KEEPER'S BACKYARD TUNNEL ESCAPE!



HELP PATRIOT ELMER EVADE THE DEEP STATE

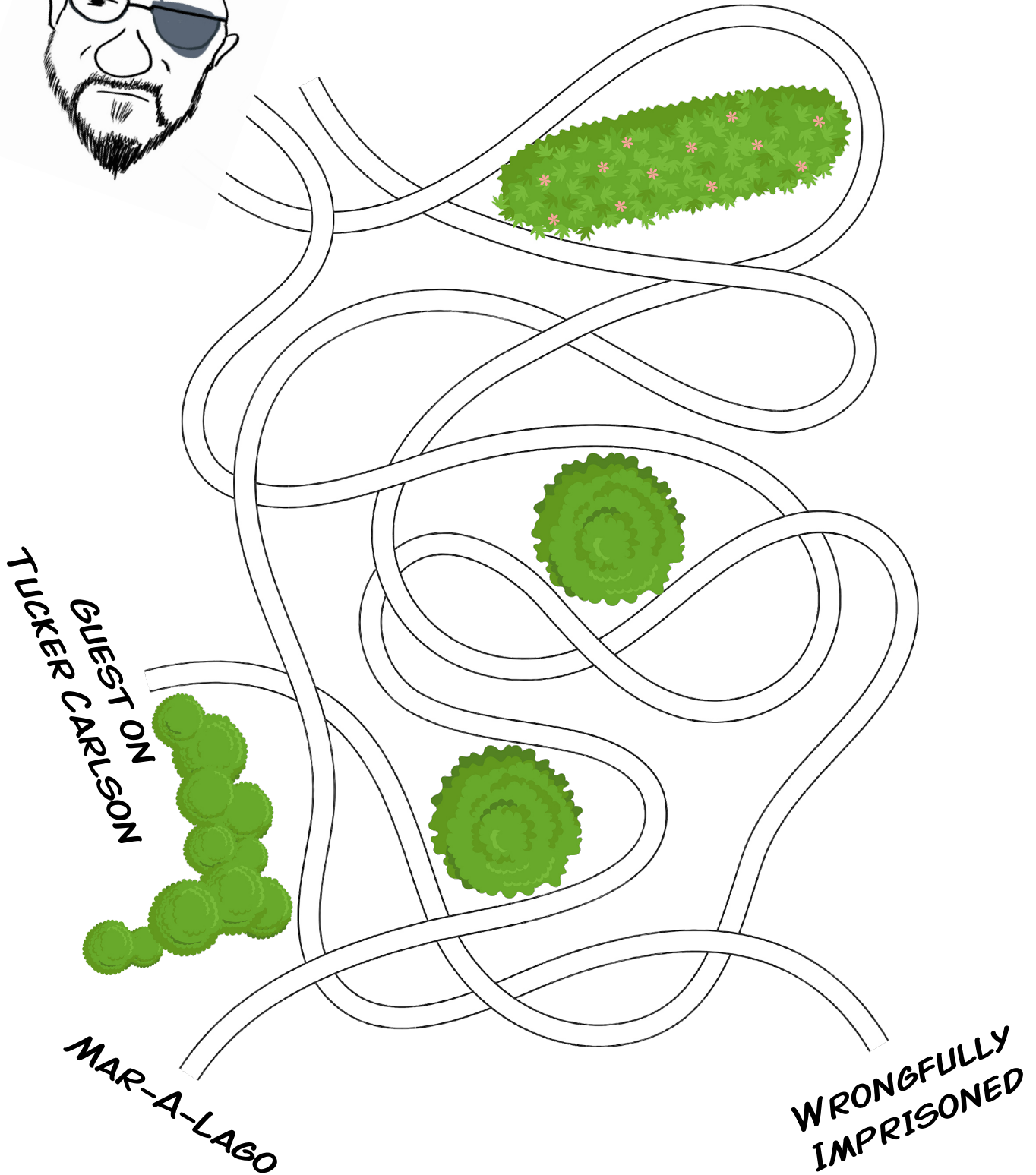

WHO HAD THE BIGGEST CROWD
MAZE

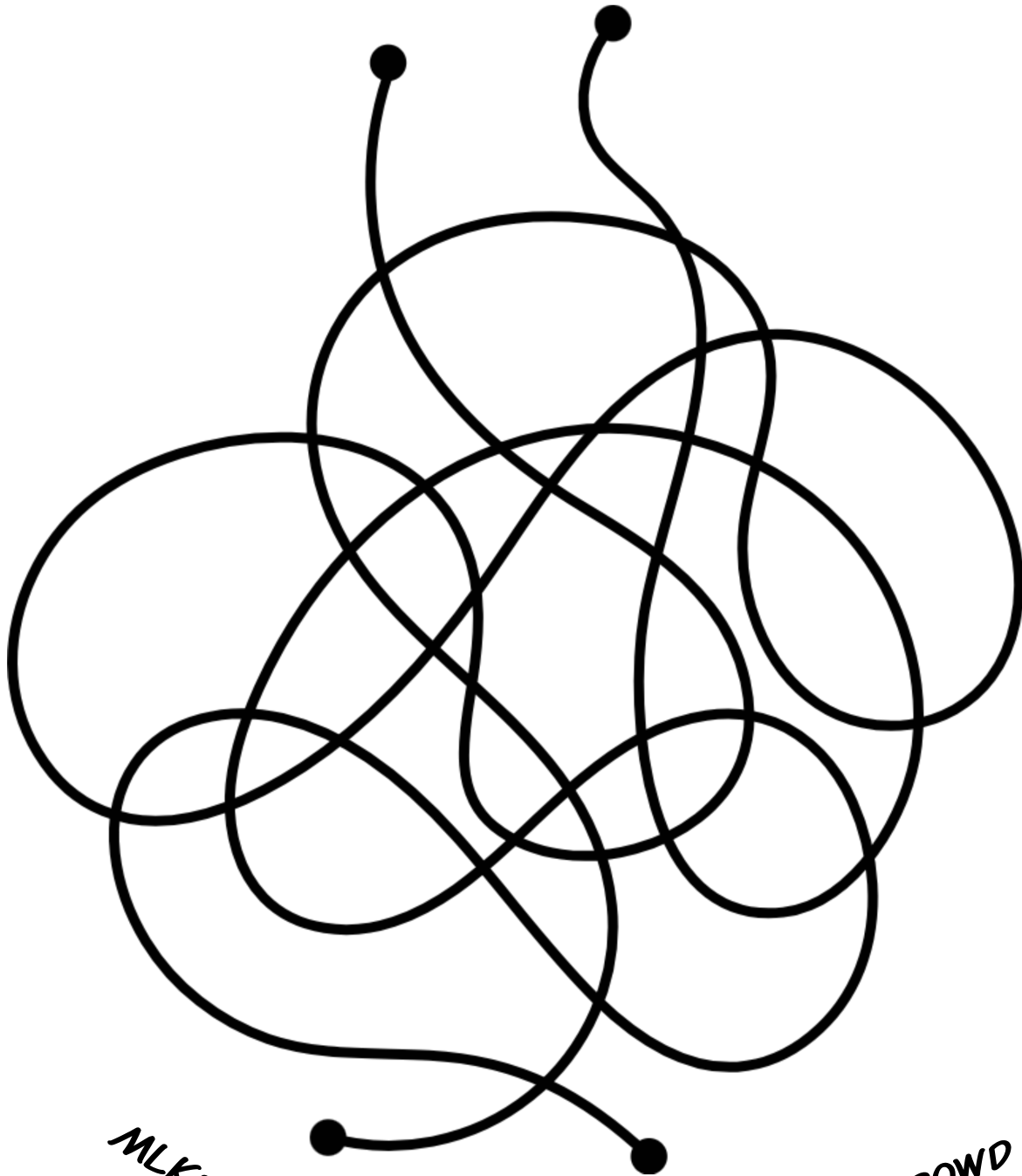

**MLK'S CROWD
WRONG!
TRY AGAIN**

**JANUARY 6 CROWD
YOU WIN!**

PATRIOT
WORD TRACING PRACTICE

Civil War

Rigged Election

Camp Auschwitz

Trial By Combat

Voter Fraud

JAWS WILL

NOT REPLACE US

COUNT THE NUMBER OF DEAD PEOPLE WHO ILLEGALLY MAILED IN BALLOTS

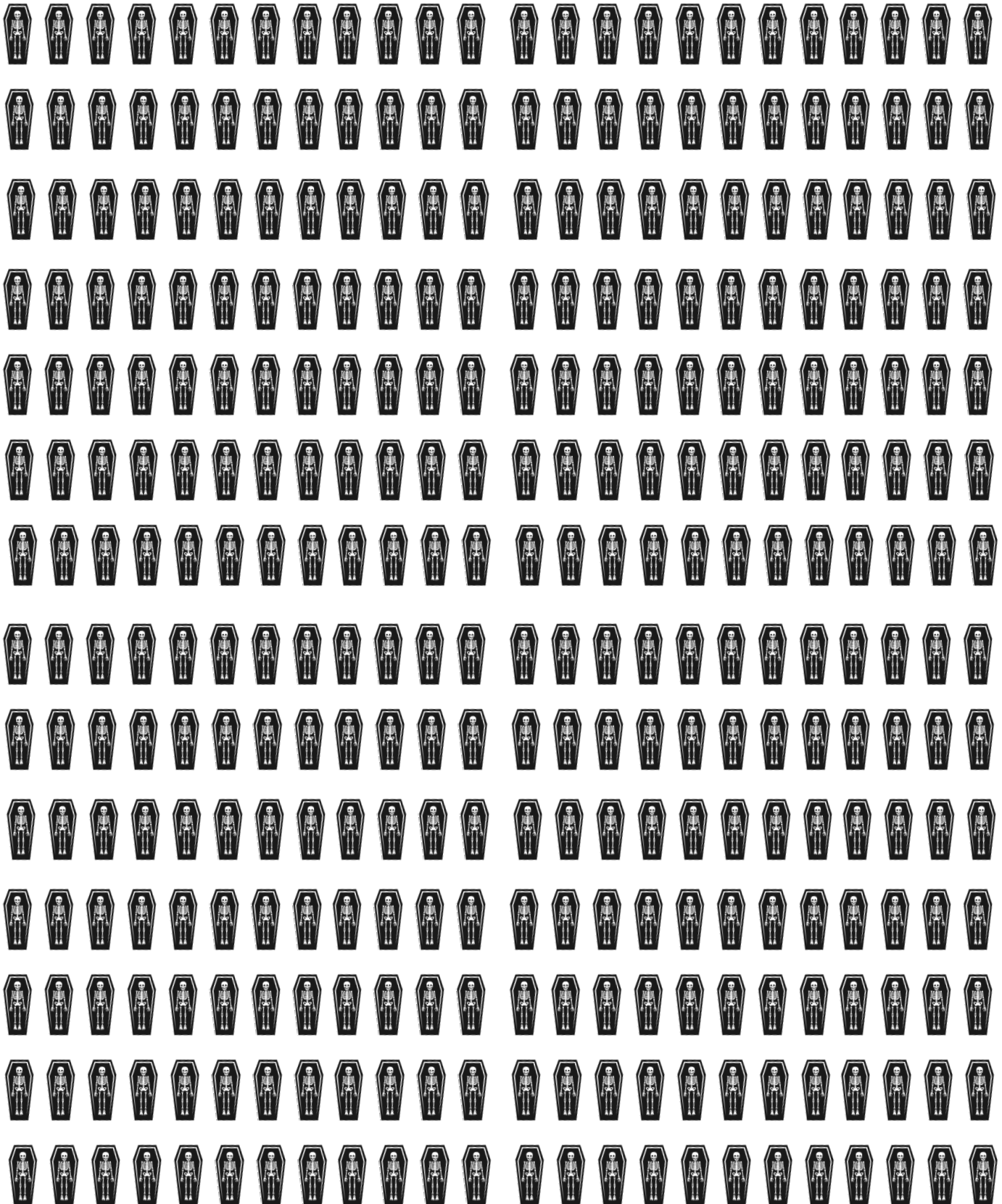

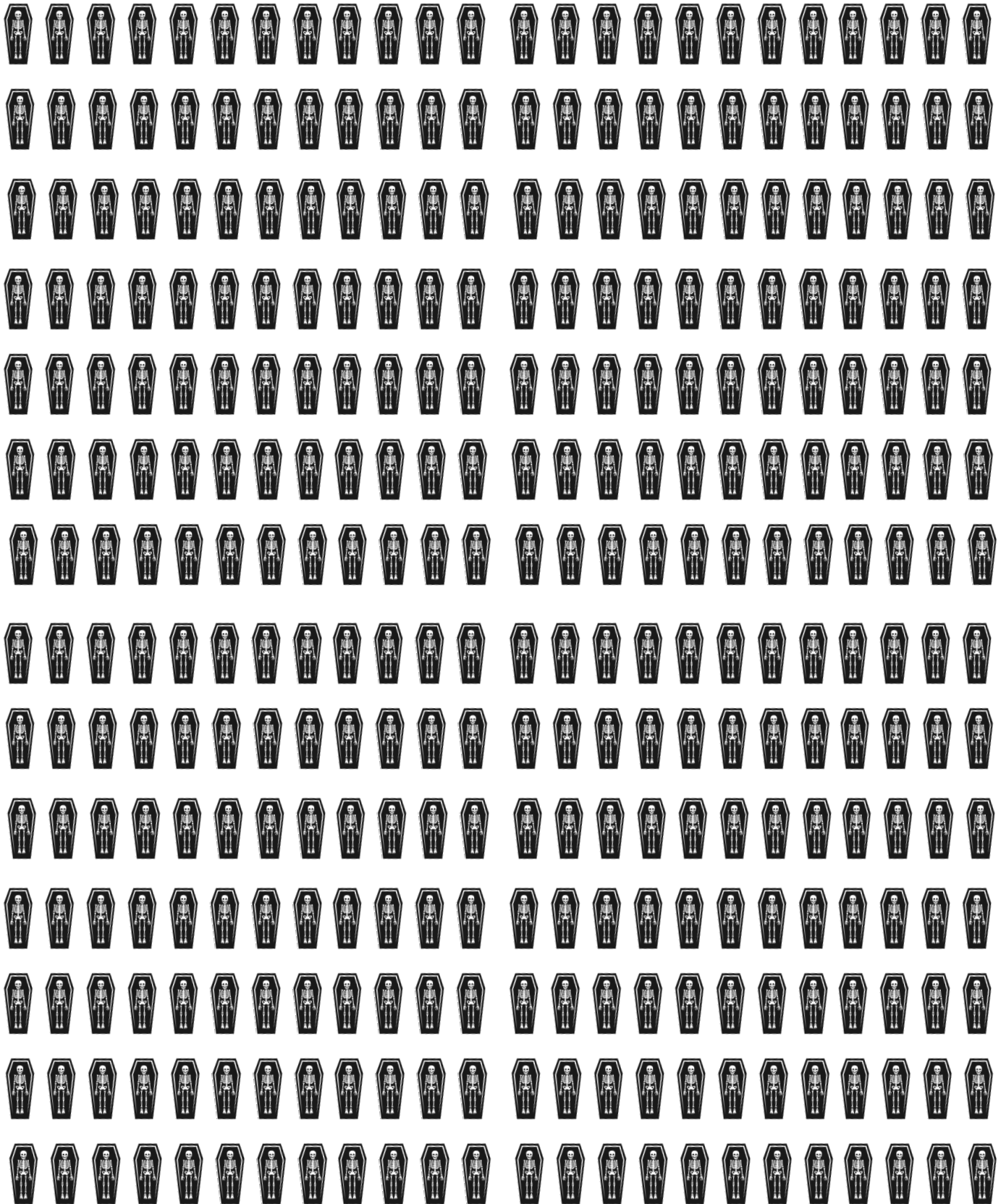

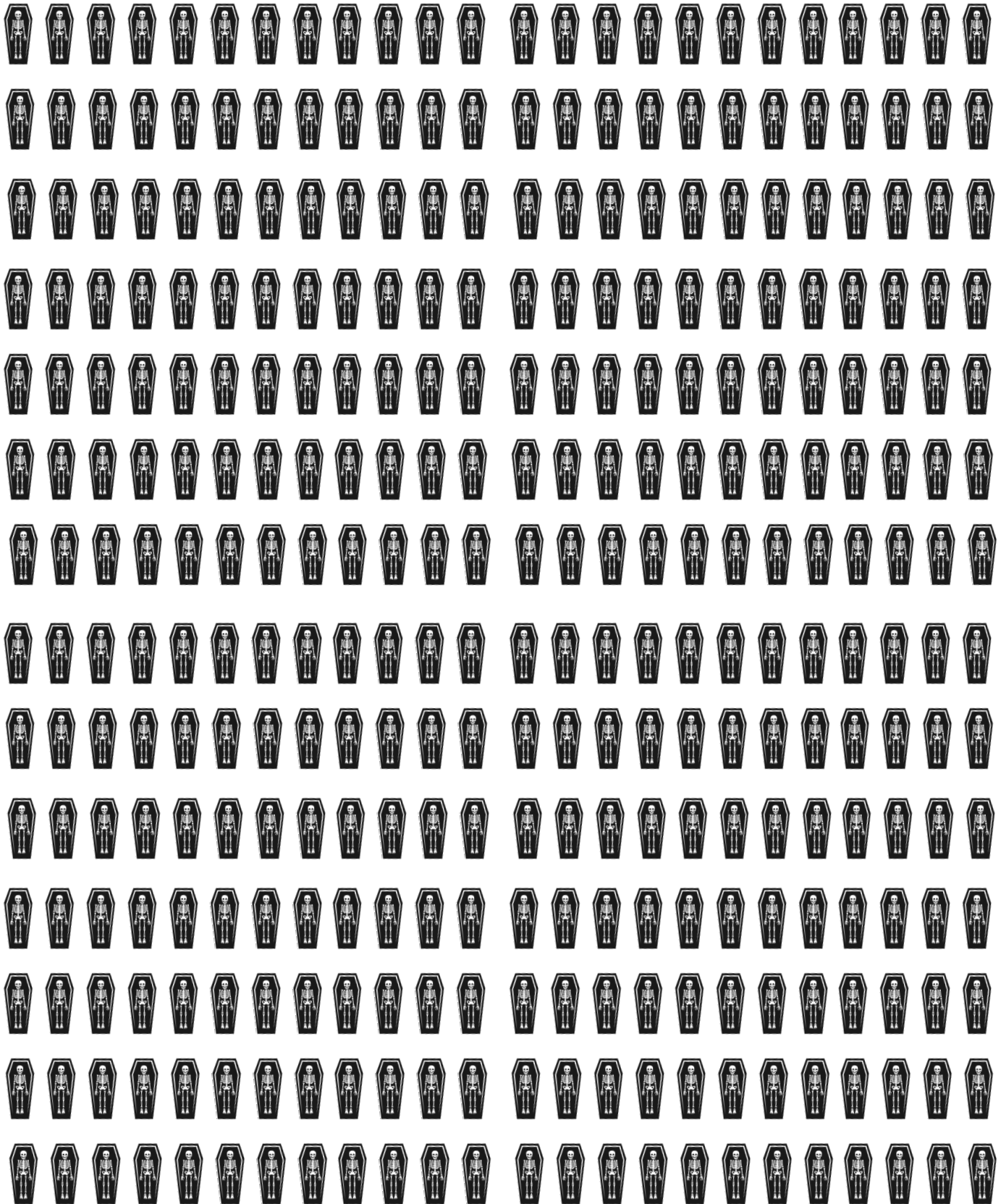

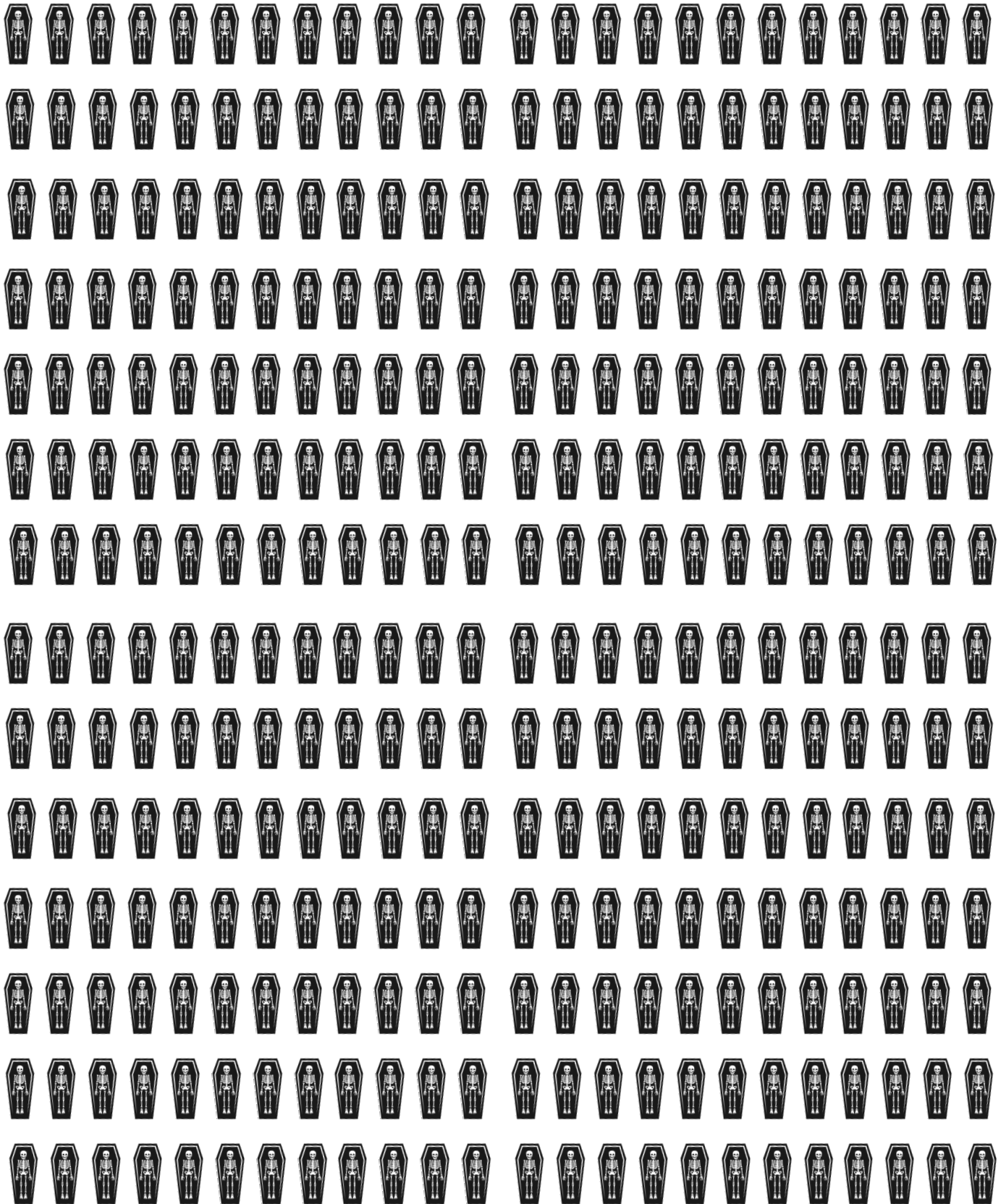

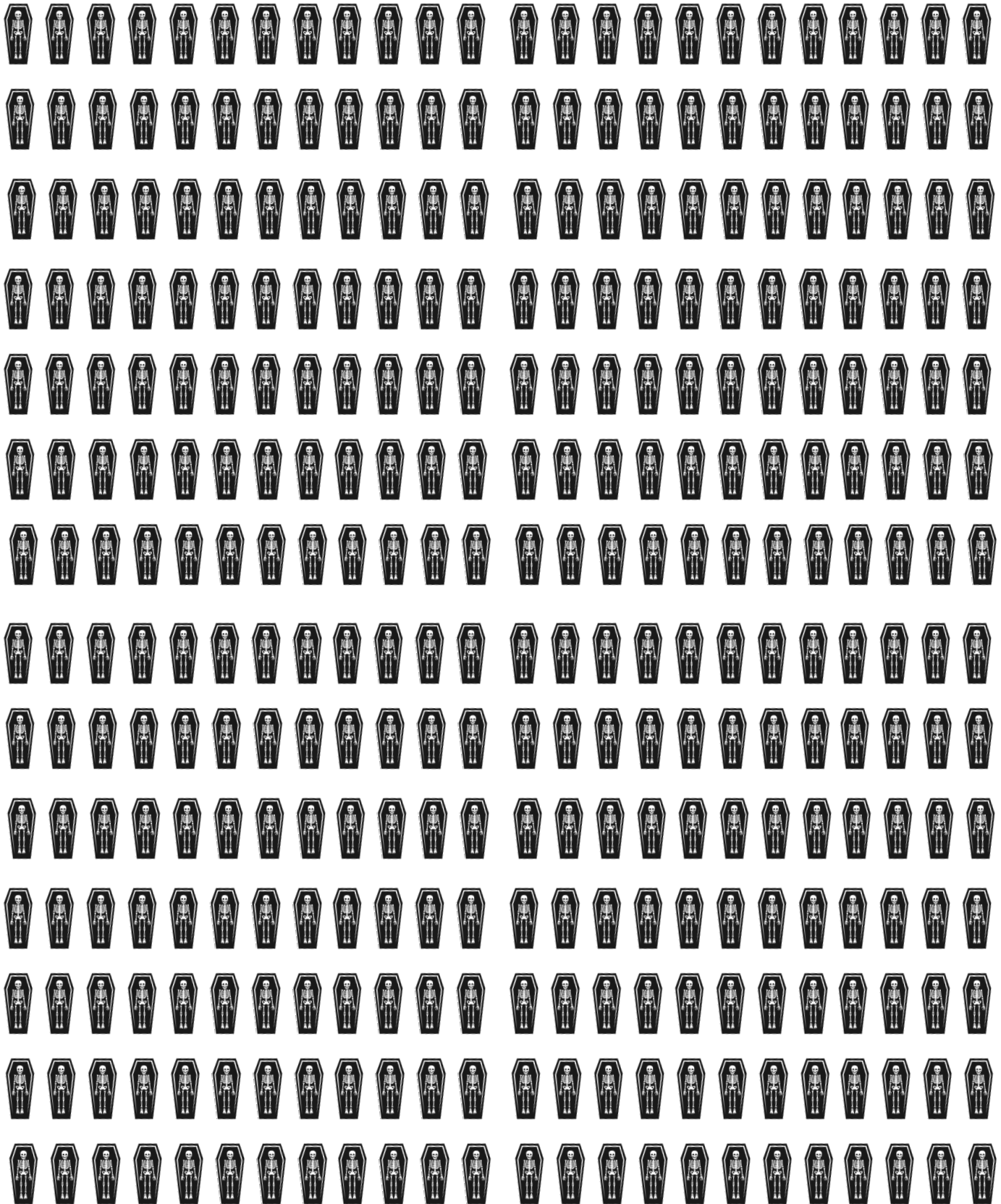

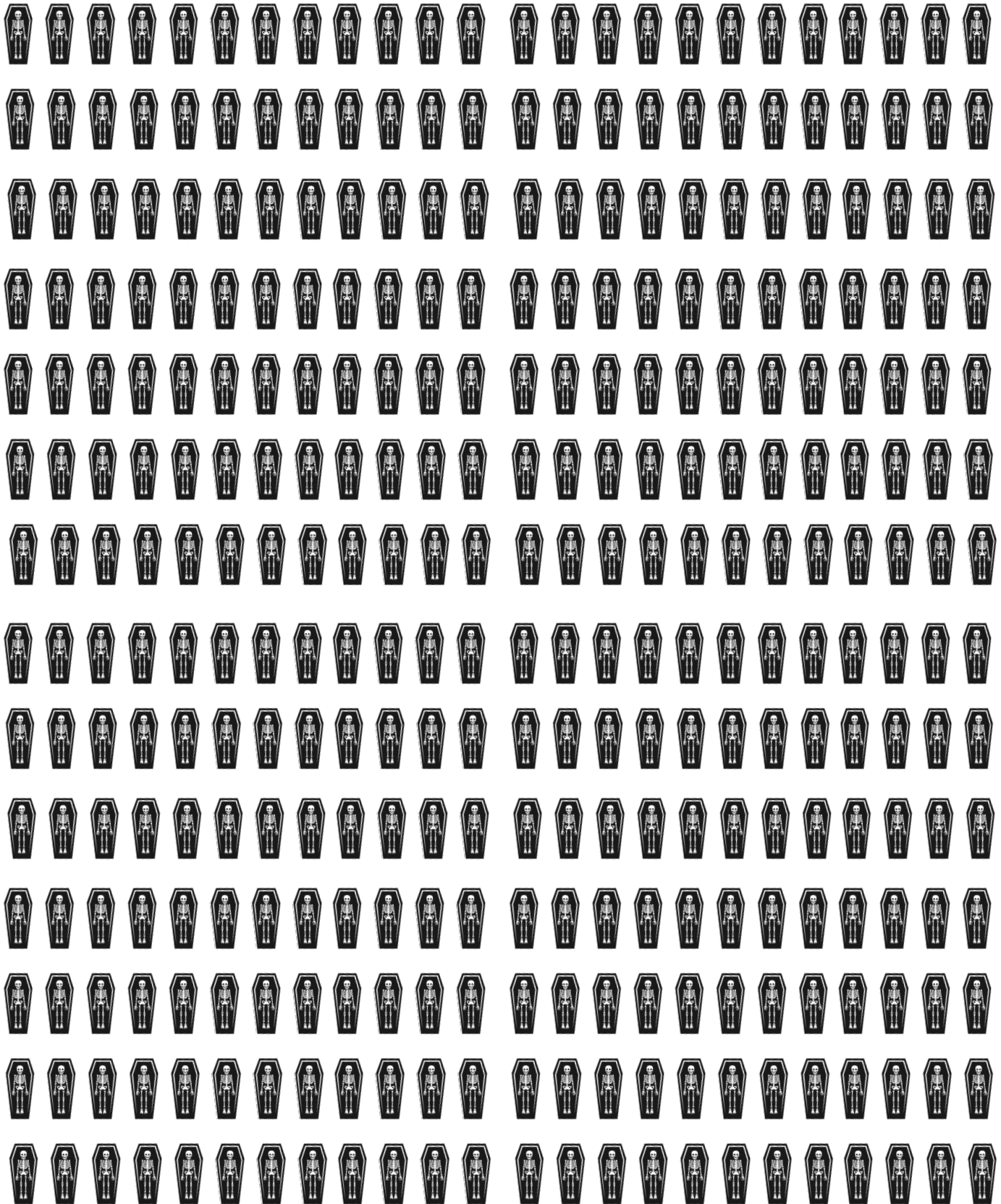

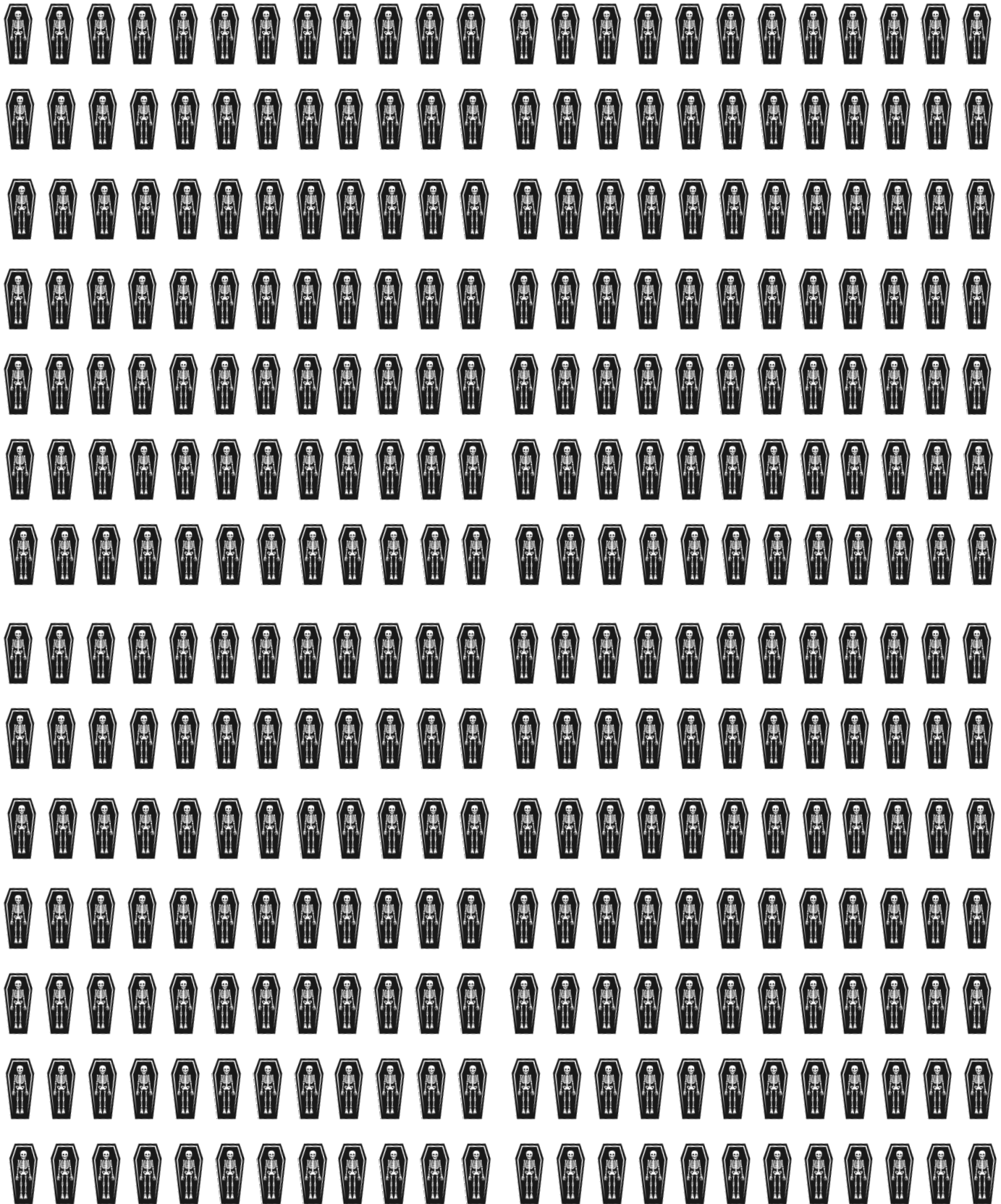

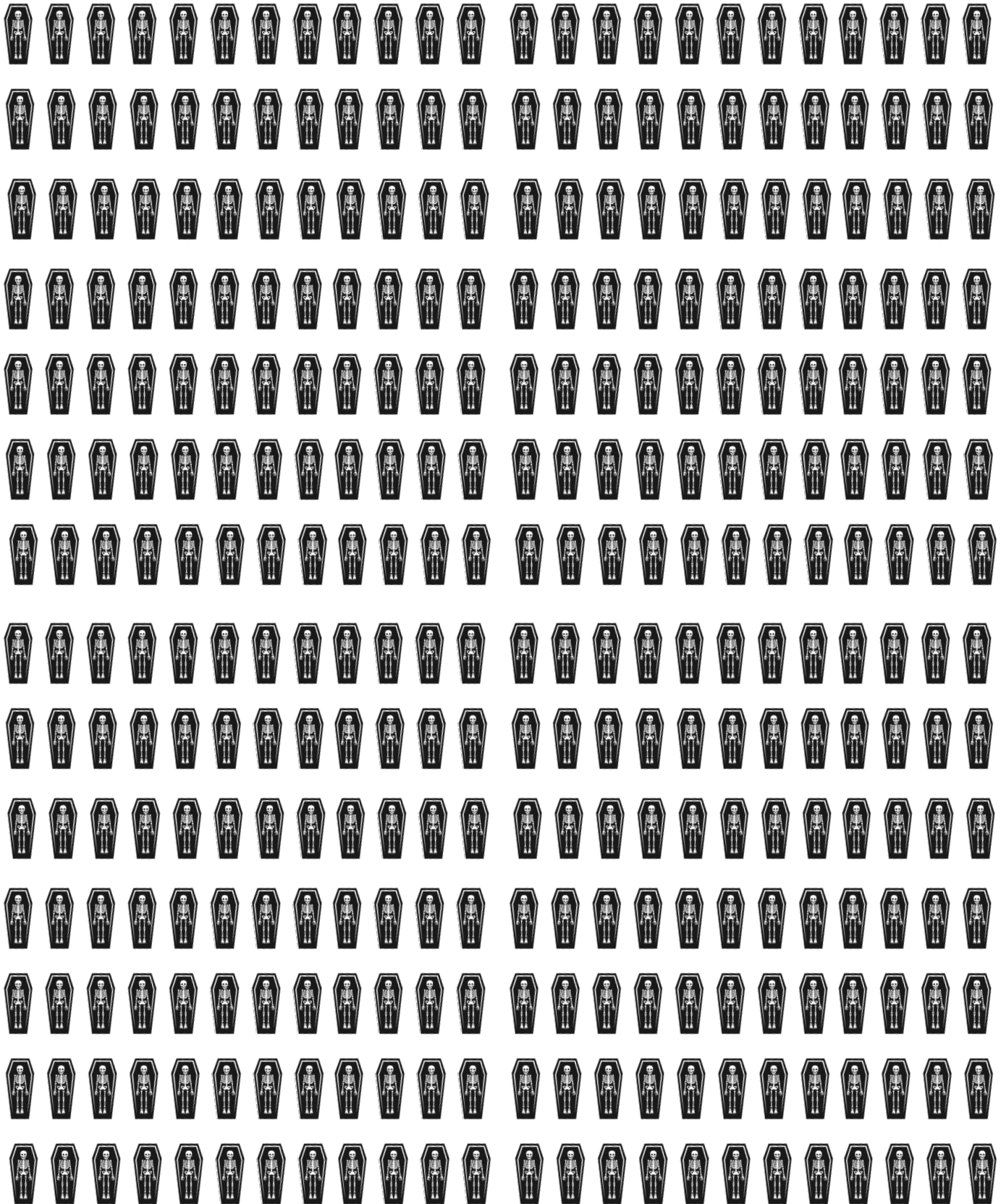

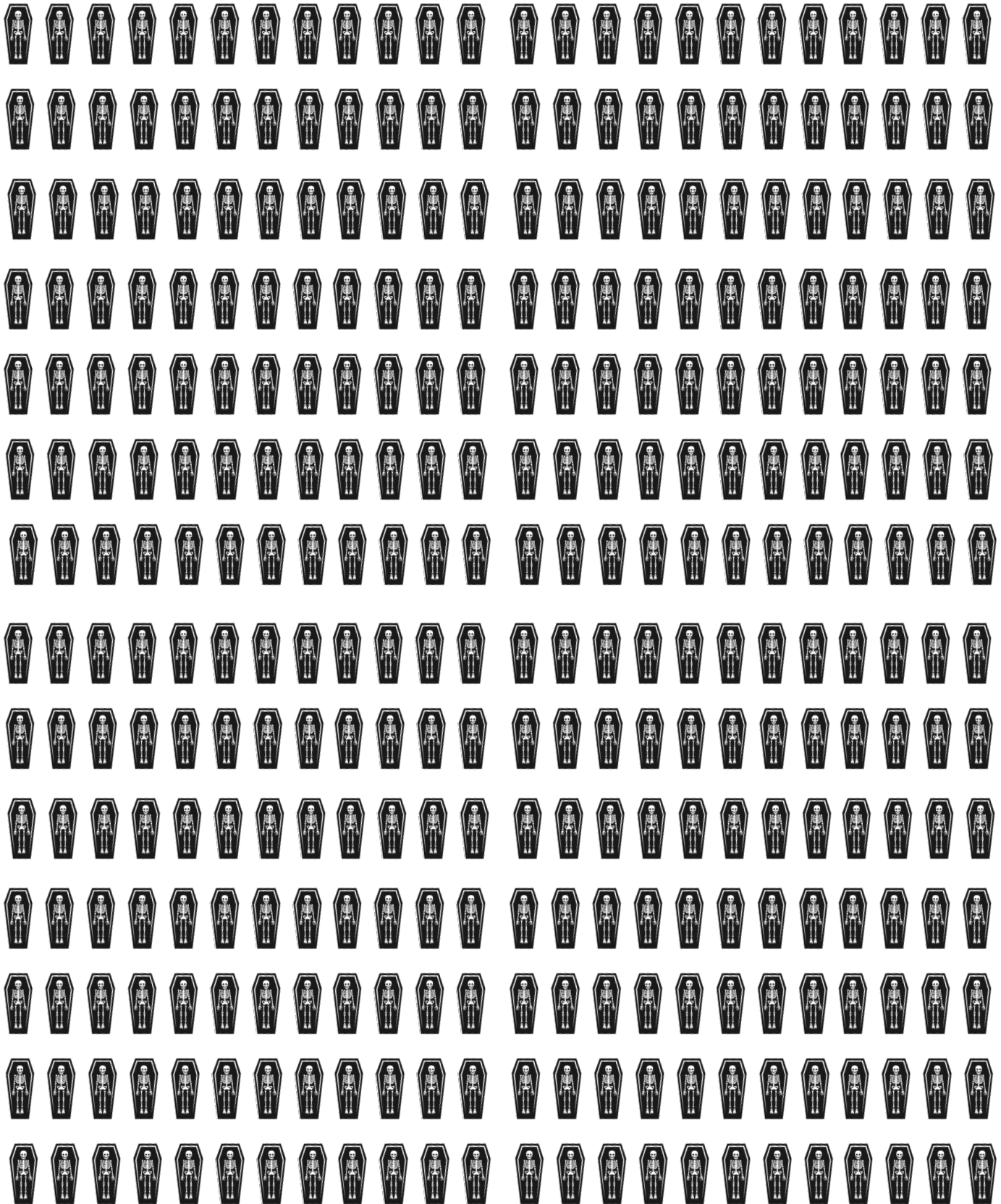

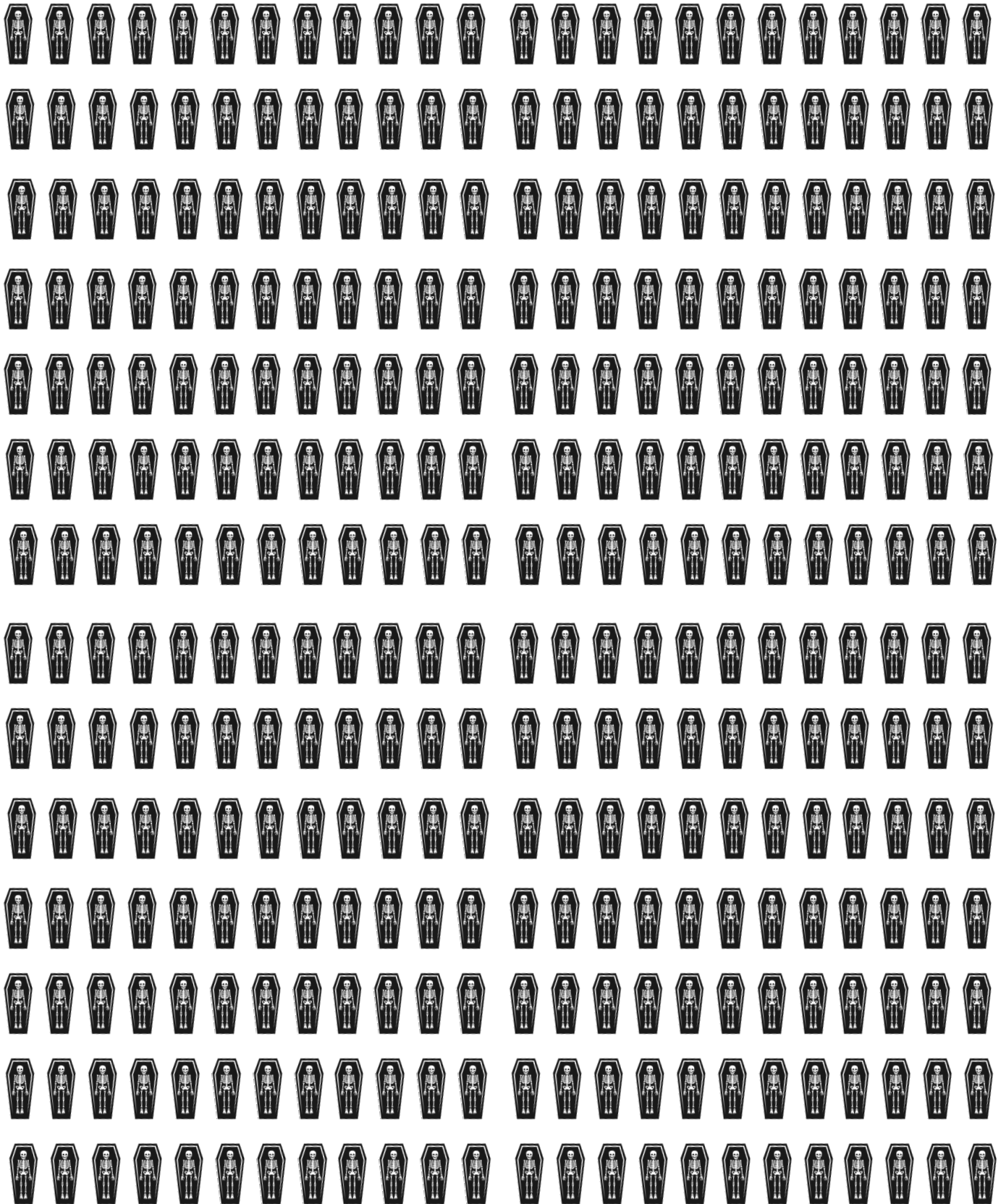

J6 EXPENSE TRACKER

<i>DATE</i>	<i>DESCRIPTION</i>	<i>AMOUNT</i>	<i>CASH</i>	<i>CREDIT</i>	<i>BARTER</i>
116121	COMFORT INN ROOM	\$	<input type="checkbox"/>	<input type="checkbox"/>	<input type="checkbox"/>
116121	CONFEDERATE FLAG	\$	<input type="checkbox"/>	<input type="checkbox"/>	<input type="checkbox"/>
116121	BEAR MACE	\$	<input type="checkbox"/>	<input type="checkbox"/>	<input type="checkbox"/>
116121	EYE PATCH	\$	<input type="checkbox"/>	<input type="checkbox"/>	<input type="checkbox"/>
116121	BASEBALL BAT	\$	<input type="checkbox"/>	<input type="checkbox"/>	<input type="checkbox"/>
116121	MY PILLOW	\$	<input type="checkbox"/>	<input type="checkbox"/>	<input type="checkbox"/>
116121	PISTOL	\$	<input type="checkbox"/>	<input type="checkbox"/>	<input type="checkbox"/>
116121	ANOTHER PISTOL	\$	<input type="checkbox"/>	<input type="checkbox"/>	<input type="checkbox"/>
116121	GOLF CLUB	\$	<input type="checkbox"/>	<input type="checkbox"/>	<input type="checkbox"/>
116121	RIFLE	\$	<input type="checkbox"/>	<input type="checkbox"/>	<input type="checkbox"/>
116121	SNAKE FLAG	\$	<input type="checkbox"/>	<input type="checkbox"/>	<input type="checkbox"/>
116121	BENGAY	\$	<input type="checkbox"/>	<input type="checkbox"/>	<input type="checkbox"/>
116121	BUFFACoon HAT	\$	<input type="checkbox"/>	<input type="checkbox"/>	<input type="checkbox"/>
116121	BUNION PADS	\$	<input type="checkbox"/>	<input type="checkbox"/>	<input type="checkbox"/>
116121	CAMP AUSCHWITZ SHIRT	\$	<input type="checkbox"/>	<input type="checkbox"/>	<input type="checkbox"/>
116121	LAWYERS	\$	<input type="checkbox"/>	<input type="checkbox"/>	<input type="checkbox"/>

BONUS
MAKE AMERICA GREAT AGAIN
ACTIVITIES

HELP PRESIDENT TRUMP SHOOT SOMEONE ON 5TH AVE MAZE

THE RADICAL LEFT HAS WEAPONIZED THE DOJ AND
STRIPPED THE PRESIDENT OF HIS RIGHT TO OWN A GUN
IN NYC. IT'S YOUR TURN TO STEP UP AS A TRUE PATRIOT!

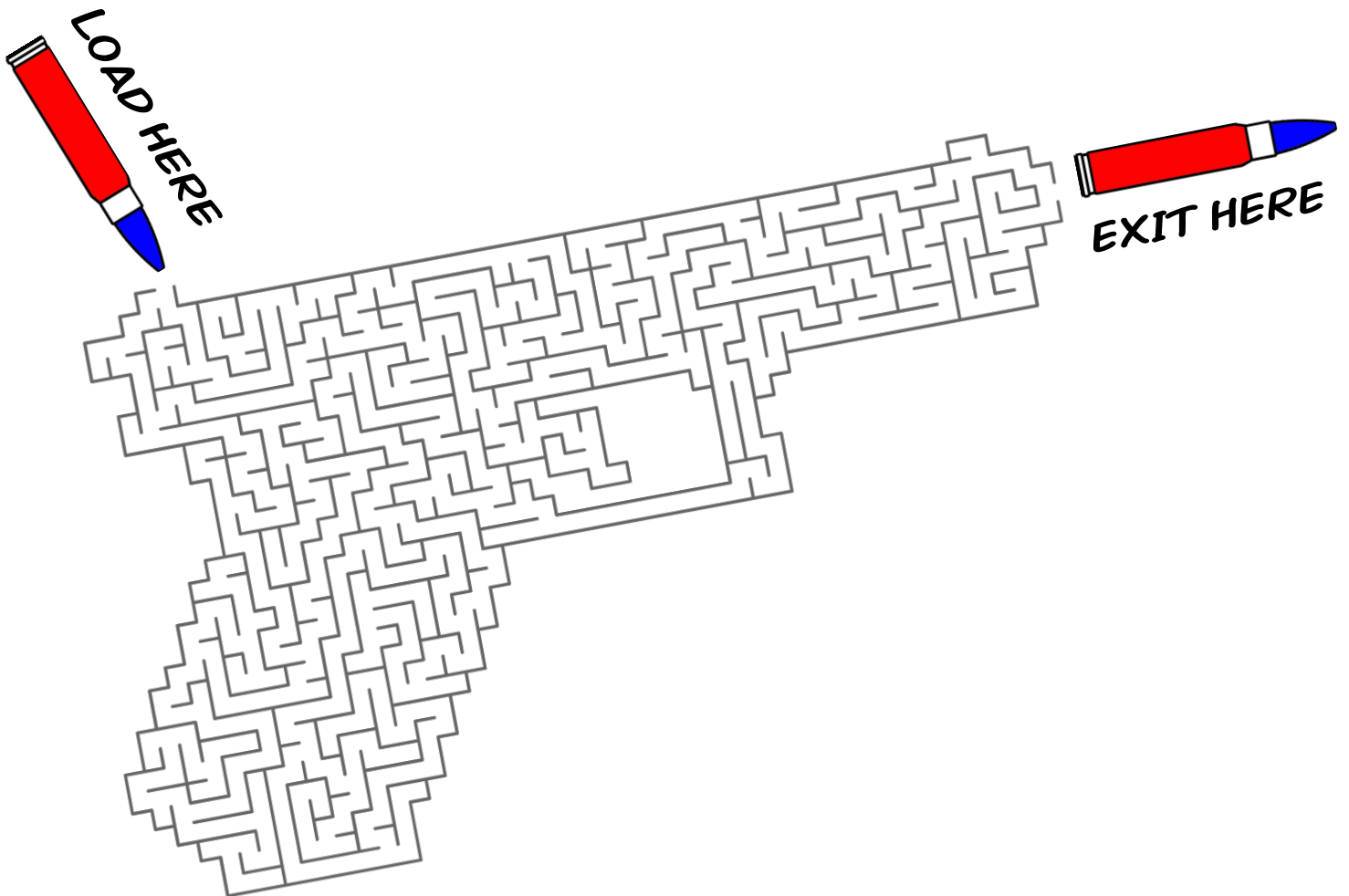

**THE CONSTITUTION IS IMPORTANT
BECAUSE.....?**

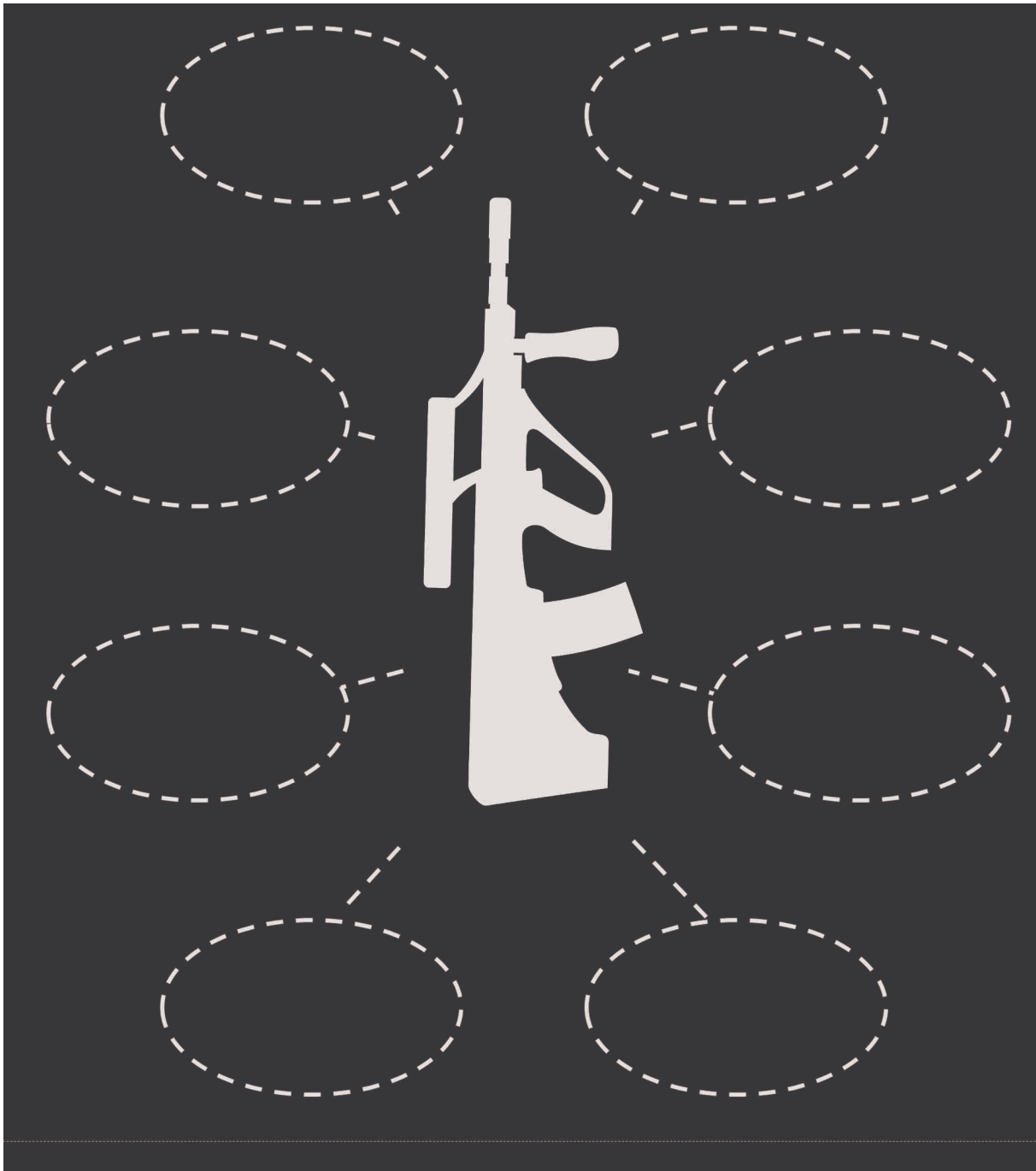

CUT AND PASTE

2ND AMENDMENT	2ND AMENDMENT	2ND AMENDMENT	2ND AMENDMENT
2ND AMENDMENT	2ND AMENDMENT	2ND AMENDMENT	2ND AMENDMENT

*FIND THE HAT THAT DOESN'T
BELONG AT THE TRUMP REALLY*



MISSING VOWELS CONGNITIVE TEST

ARE YOU AS SMART AT THE PRESIDENT?

FILL IN THE MISSING VOWELS

P _ R S _ N

M _ N

W _ M _ N

C _ M _ R _

T _

CROOKED HILLARY BODY COUNT **WORD SEARCH**

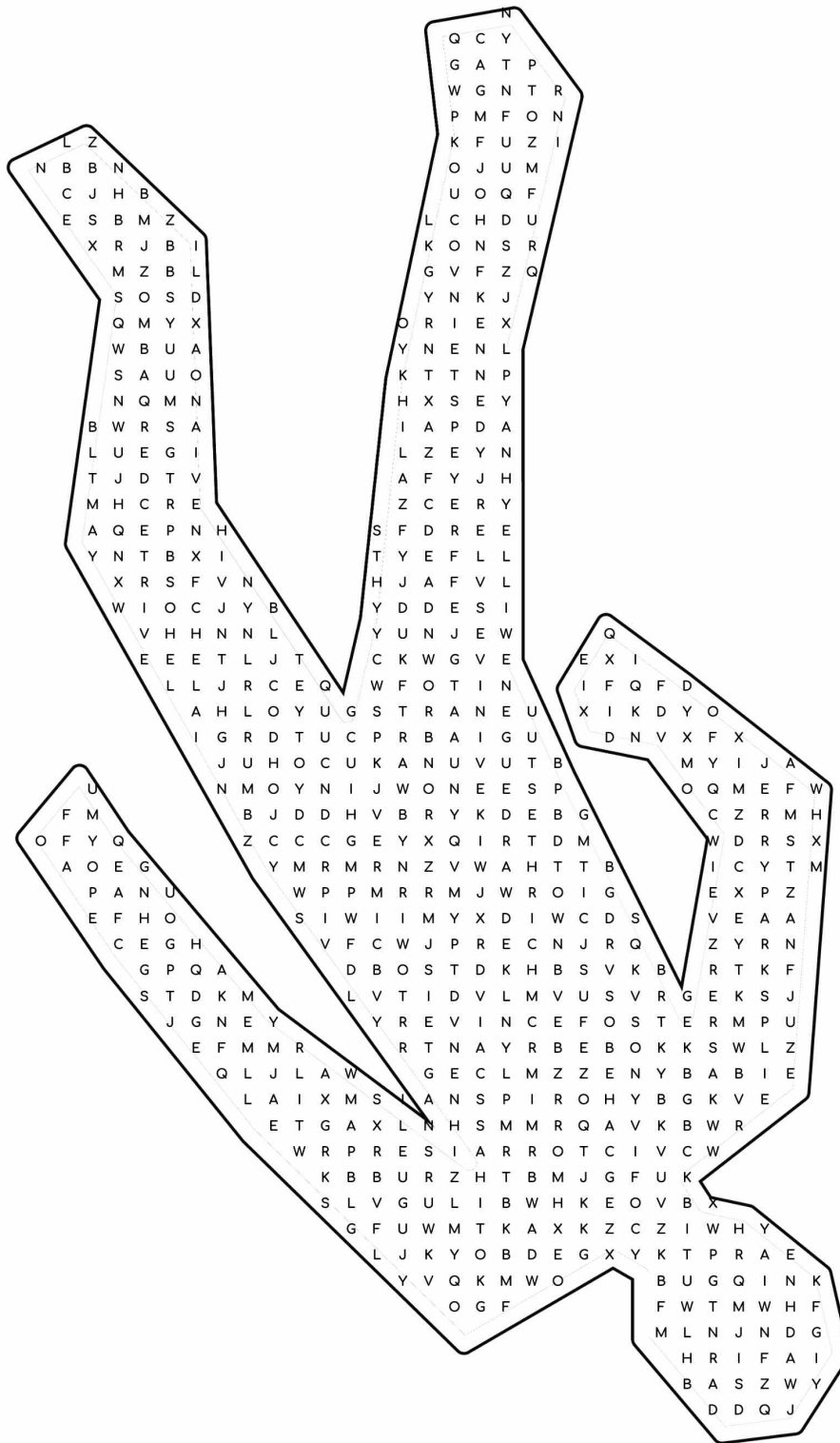

DON HENRY
KEVIN IVES
C VICTOR RAISER
IAN SPIRO

MARY MAHONEY
VINCE FOSTER
JERRY PARKS
EDWARD EUGENE WILLEY

RON BROWN
JIM McDOUGAL
JOHN F KENNEDY JR
SETH RICH

ESCAPE THE FAUCI COVID 19 VACCINE MANDATE

MAZE

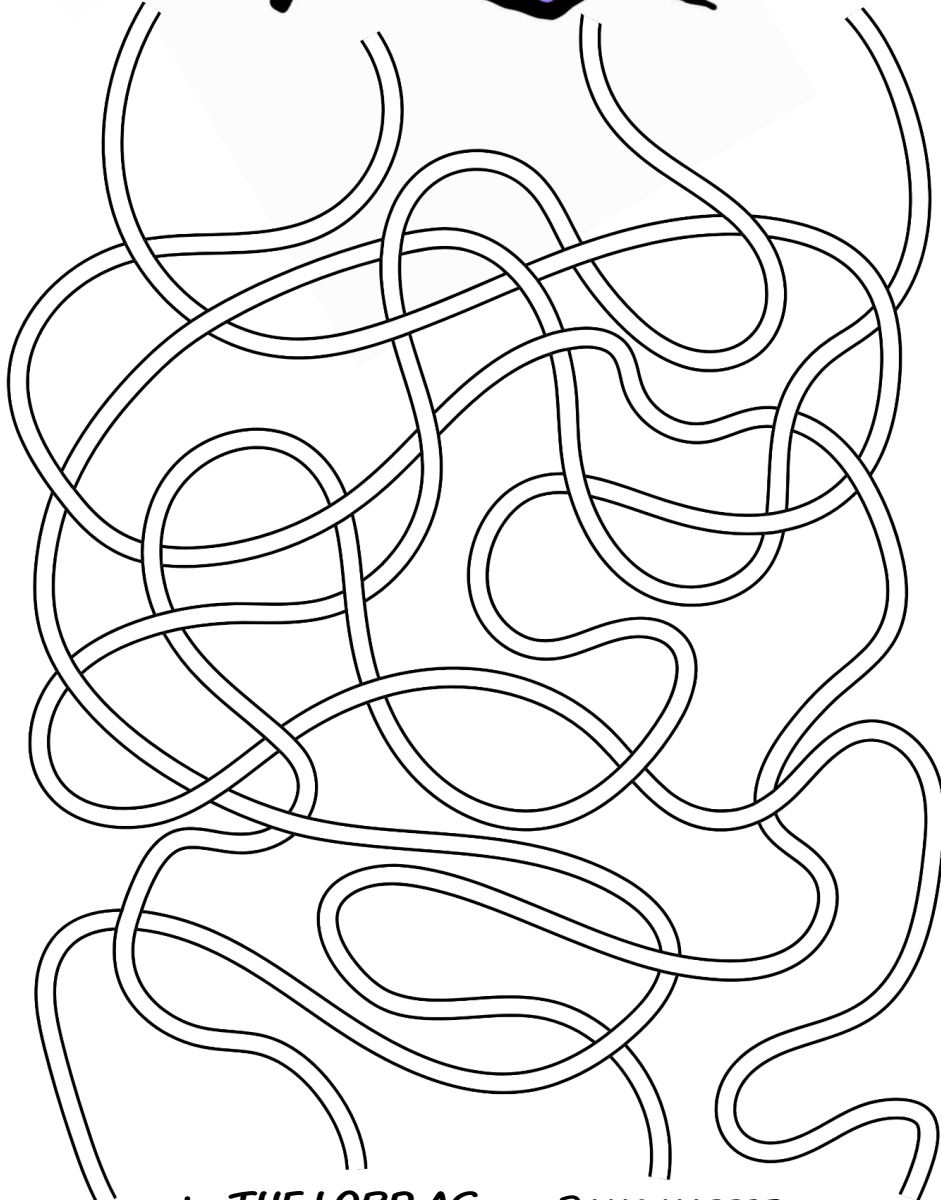
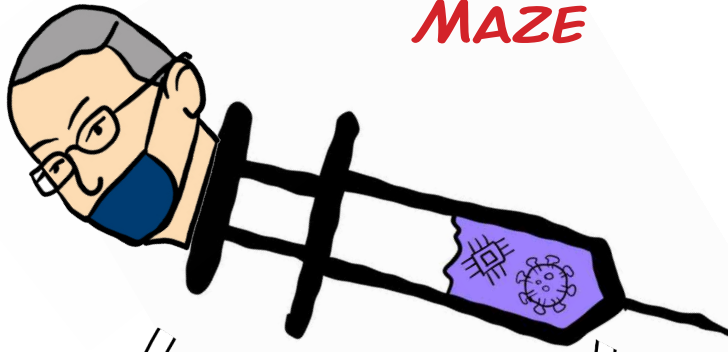

CONGRATULATIONS!
YOU WON A YEAR
SUPPLY OF HORSE
DEWORMER!

THE LORD AS
MY WITNESS
YOU'VE BEEN
CHIPPED BY
BILL GATES

DANG NABBIT
YOU'RE
MAGNETIC
FROM THE
ALIEN DNA
DEMON SPERM

AUTISM

SAVE THE FETUS MAZE!

SAVE THE UNBORN PATRIOT FROM A LATE TERM ABORTION BY A SATANIC LIB ABORTIONIST OR FROM BEING ADOPTED BY A GAY COUPLE. HELP THE GIRL SUBMIT TO JESUS AND KEEP HER RAPIST'S BABY

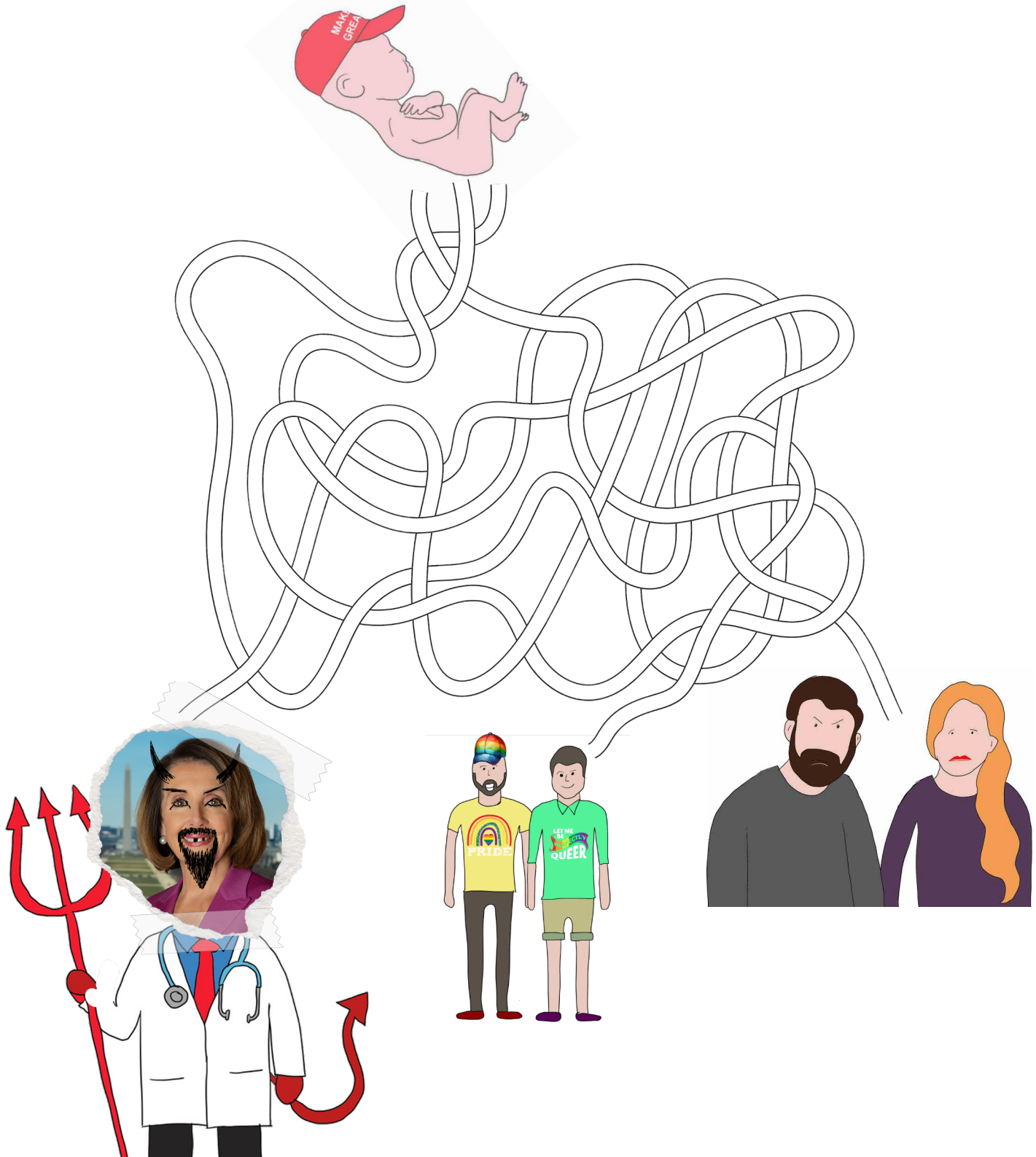

HELP GOD INTERVENE AND STOP THE ANTIFA BULLETS FROM HITTING PRESIDENT TRUMP MAZE!

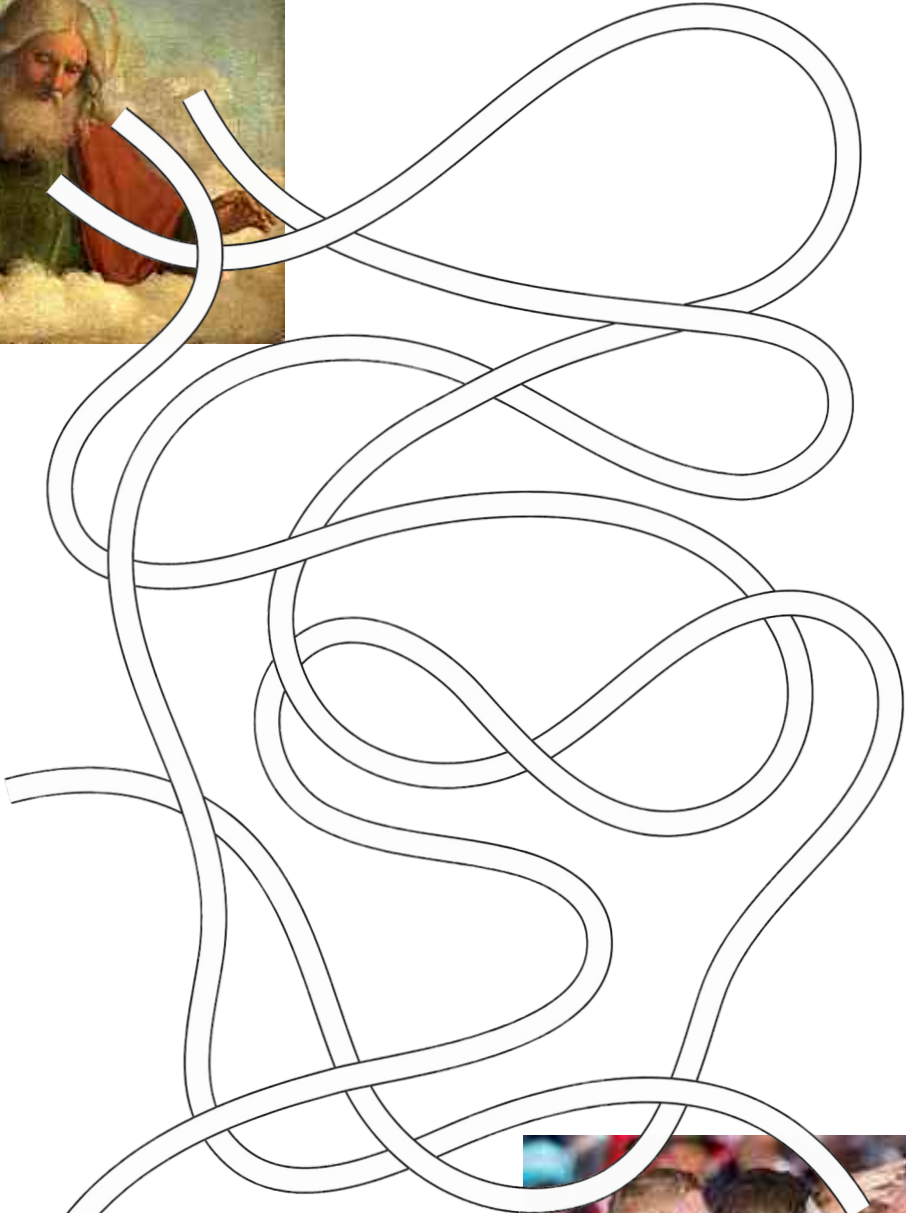

COMMEMORATIVE PRESIDENTIAL EAR BANDAGE

CUT. FOLD. TAPE.

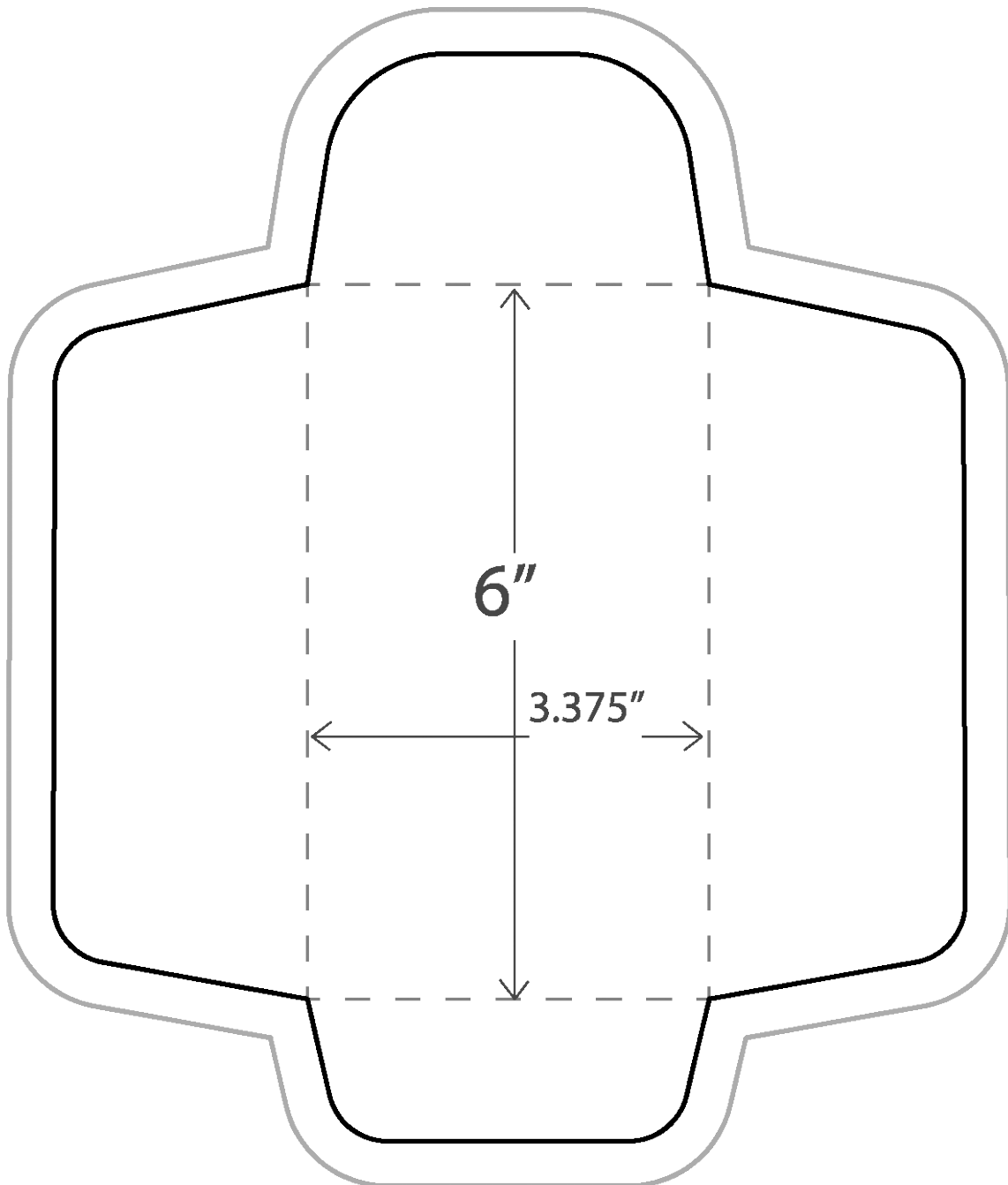

NOT FOR LEGAL FEES DONATIONS

EACH DONATION INCLUDES A SPECIAL GIFT

- \$5** **RECEIPT FOR YOUR DONATION**
- \$10** **PIECE OF TRUMP STEAK CHEWED BY DON JR.**
- \$20** **RECORDING OF TRUMP FIRING BRANDON**
- \$40** **THE ORIGINAL US CONSTITUTION SIGNED BY TRUMP**
- \$60** **PRESIDENT TRUMP'S PERSONAL BATHROOM BIBLE**
- \$80** **RIGHT TRUMP SNEAKER**
- \$90** **LEFT TRUMP SNEAKER**
- \$100** **BOX OF BATHROOM DOCUMENTS**
- \$200** **BOX OF DOCUMENTS, ONE SNEAKER, AND A GRAVE PLOT NEXT TO IVANA AT MAR-A-LAGO**

MAIL CASH OR CHECK TO:

MAR-A-LAGO, FLORIDA

MAKE CHECKS PAYABLE TO "CASH"

*SIGN UP FOR **FREE***
PRINTABLE ACTIVITY PAGES
AND UPDATES AT
WWW.THEPUZZLINGTIMES.NET

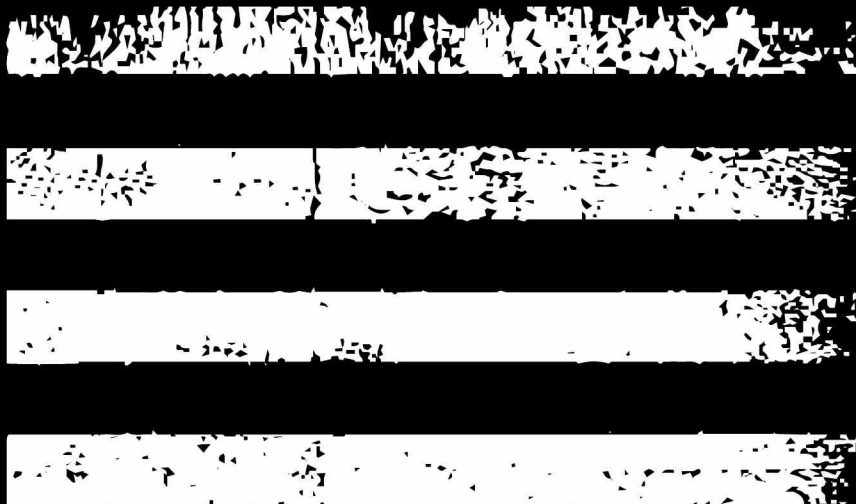
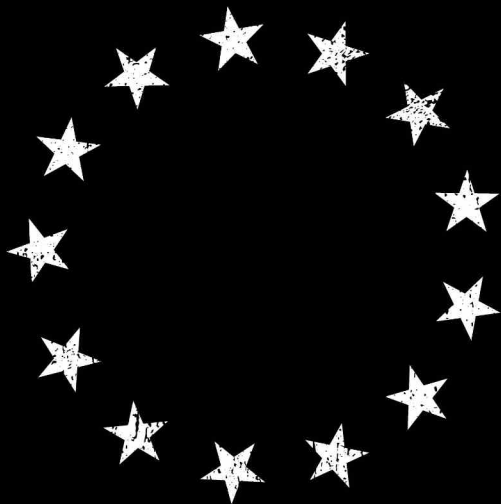

DECODE QANON MESSAGE
QDROPTOGRAMS

A	B	C	D	E	F	G	H	I	J	K	L	M
4	1	26	8	7	13	16	2	14	19	18	20	23

N	O	P	Q	R	S	T	U	V	W	X	Y	Z
3	9	25	22	6	15	10	17	5	21	11	24	12

ANSWER

10	2	7	15	10	9	6	23

49

AMERICAN

ALSO AMERICAN

5

**CANNIBALISTIC SATAN
WORSHIPPING PEDOS ARE
OPERATING A SECRET
FRANCHISABLE GLOBALIST
PIZZA PARLOR RING AND
PLOTTING AGAINST
PRESIDENT DONALD TRUMP
TO STEAL THE ELECTION!!!!**

**IT'S NOW YOUR TURN TO
FIGHT LIKE HELL
AND SAVE....**

America!!!!!!

5

Barcode